

Overview

HPE ProLiant ML110 Gen10 Server

The HPE ProLiant ML110 Gen10 delivers a performance that meets the growing needs of the SMB. The server is a single processor, 4.5U Tower Server that is designed to provide enterprise class features such as redundancy, reliability, and manageability. The server delivers the right size Tower with performance and expandability that covers a wide range of applications and workloads and addresses our customers from SMB to enterprise class server ROBO environments. Accelerate your business with this right-sized compute.

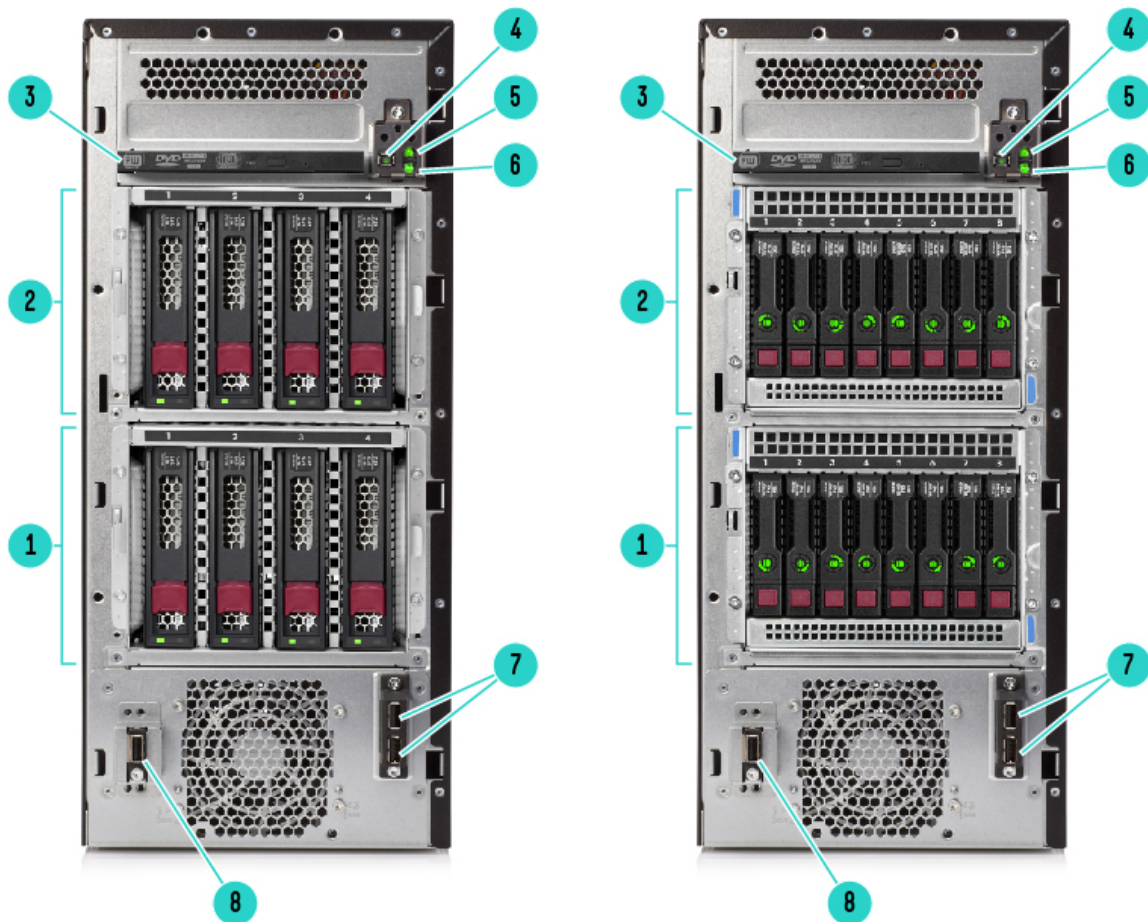

Front View (details for 8LFF and 16SFF)

- | | | | |
|----|--------------------------|----|-------------------------|
| 1. | Drive Cage 1 | 2. | Drive Cage 2 (optional) |
| 3. | Optical drive (optional) | 4. | Power button/ LED |
| 5. | Health LED | 6. | NIC status LED |
| 7. | USB 3.0 (2) connectors | 8. | iLO Service Port |

Overview

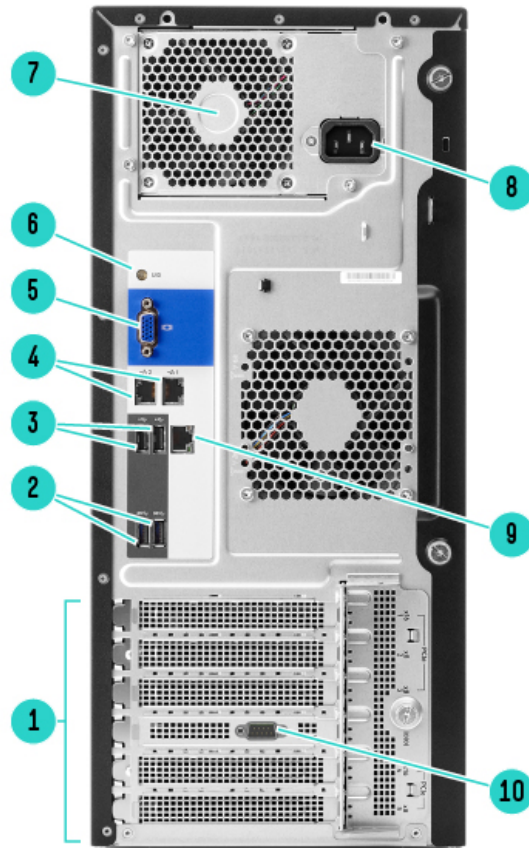

Rear View

1. PCIe3.0 Slots (Slots 1-5)
2. USB 3.0 (2) connectors
3. USB 2.0 (2) connectors
4. Network RJ-45 ports (2)
5. VGA port
6. UID button/LED
7. Power supply bay
8. Power supply power connection
9. iLO management port
10. Serial port (optional)



Overview

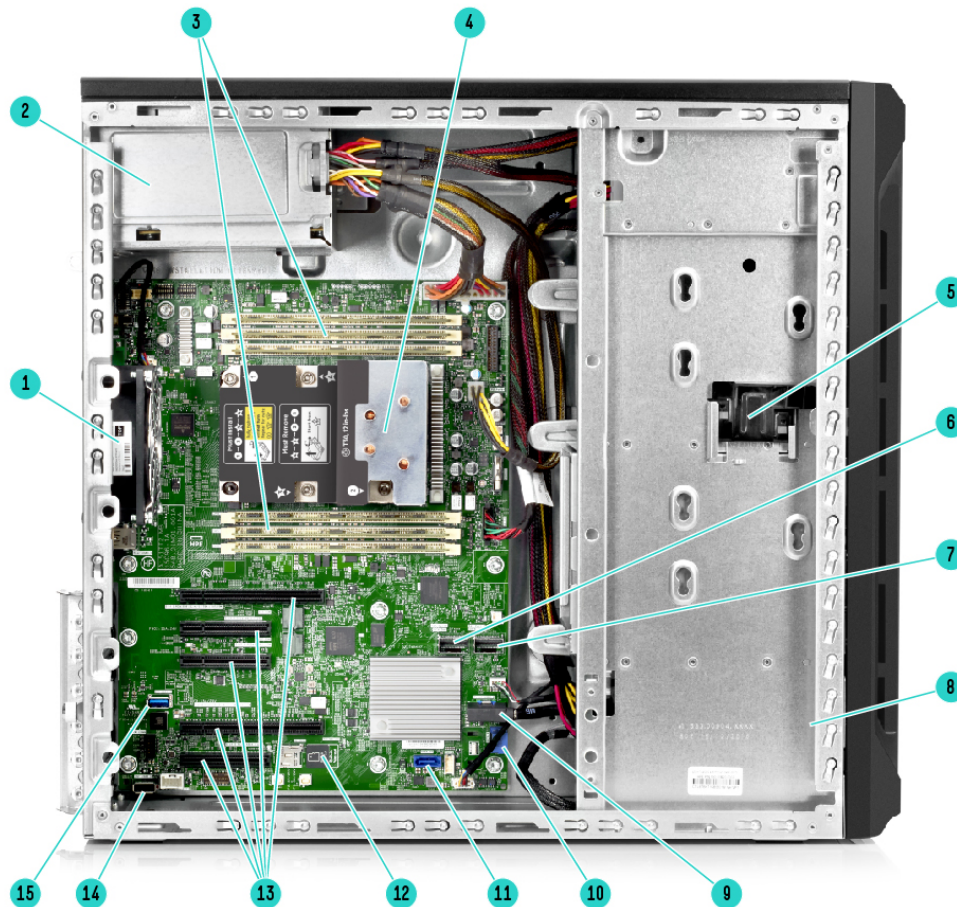

Internal View

- | | |
|---|---|
| <ol style="list-style-type: none"> 1. System Fan (92x32mm default) 3. Six (6) DDR4 DIMM slots 5. Front Bezel Lock 7. X4 SATA Port 1 (1-4) 9. Front USB 3.0 connector 11. SATA Port 10 13. Five (5) PCIe3.0 expansion slots 15. Internal USB 3.0 connector | <ol style="list-style-type: none"> 2. Power Supply 4. One (1) processor and heatsink 6. X4 SATA Port 2 (5-8) 8. PCIe fan (92x32mm default) 10. SATA Port 9 12. MicroSD slot 14. Internal USB 2.0 connector |
|---|---|

What's New:

- New SMB SKU Offerings
- NVIDIA Quadro RTX4000 GPU Module (optional)
- HPE 12TB SAS/ SATA 7.2K LFF HDD
- Intel® Xeon® Scalable processors , up to 16 cores, up to 110W
- Redundant Fan Kit (optional)
- Support up to 8 LFF NHP SATA HDDs
- HPE DDR4 SmartMemory up to 2933 MT/s
- Security features: iLO 5 (Security Root of Trust)
- European Union (EU) Lot 9 regulation, please visit:
<https://www.hpe.com/us/en/about/environment/msds-specs-more.html> for more information

Overview

Platform Information

Form Factor

- Tower (4.5U)

Notes: Sliding Shelf - 874578-B21 is optional to support rack form factor.

System Fans

- 1 Default system fan module (92 x 32 mm)
- 1 Default PCIe fan module (92 X 32 mm)

Notes: When one of the following scenarios occurs, the server requires a Redundant Fan with a 800W Redundant Power Supply to be installed.

- When a second HDD cage is installed and the SAS HDDs are running at 15K RPM.
 - When a SAS SSD is installed.
 - If one fan fails, the system will be required to continue operating with a Redundant Fan. This condition is indicated by a flashing amber Health LED.
 - When the system requirements are to meet the A3 extended operating environment.
-



Standard Features

Processors – One of the following depending on model.

Notes: For more information regarding Intel Xeon processors, please see the following <http://www.intel.com/xeon>.

Intel Second Generation Xeon® Scalable Processors							
Intel Xeon Models	CPU Frequency	Cores	L3 Cache	Power	UPI	DDR4	Memory per socket
Gold Processors							
Gold 5222 Processor	3.8 GHz	4	16.50 MB	105W	2 @ 10.4 GT/s	2933 MT/s	192 GB
Gold 5218N Processor	2.3 GHz	16	22.00 MB	110W	2 @ 10.4 GT/s	2666 MT/s	192 GB
Gold 5215 Processor	2.5 GHz	10	13.75 MB	85W	2 @ 10.4 GT/s	2666 MT/s	192 GB
Silver Processors							
Silver 4216 Processor	2.1 GHz	16	22.00 MB	100W	2 @ 9.6 GT/s	2400 MT/s	192 GB
Silver 4215 Processor	2.5 GHz	8	11.00 MB	85W	2 @ 9.6 GT/s	2400 MT/s	192 GB
Silver 4214R Processor	2.4 GHz	12	16.50 MB	100W	2 @ 9.6 GT/s	2400 MT/s	192 GB
Silver 4214 Processor	2.2 GHz	12	16.50 MB	85W	2 @ 9.6 GT/s	2400 MT/s	192 GB
Silver 4210R Processor	2.4 GHz	10	13.75 MB	100W	2 @ 9.6 GT/s	2400 MT/s	192 GB
Silver 4210 Processor	2.2 GHz	10	13.75 MB	85W	2 @ 9.6 GT/s	2400 MT/s	192 GB
Silver 4208 Processor	2.1 GHz	8	11.00 MB	85W	2 @ 9.6 GT/s	2400 MT/s	192 GB
Bronze Processors							
Bronze 3206R Processor	1.9 GHz	8	8.25 MB	85W	2 @ 9.6 GT/s	2133 MT/s	192 GB
Bronze 3204 Processor	1.9 GHz	6	8.25 MB	85W	2 @ 9.6 GT/s	2133 MT/s	192 GB

Notes:

- Gold – 5200 Series - Supports 6-Channel DDR4 @2666 MT/s of SKU 5215 and 5218N, @2933 MT/s of SKU 5222 providing up to 192 GB memory capacity. Intel Turbo Boost Technology, Intel Hyper-Threading Technology, Intel AVX-512(1x 512-bit FMA) (SKU 5222 supports 2x 512 bit FMA), 48 lanes PCIe 3.0, advanced RAS supported.
- Silver – 4200 Series -6-Channel DDR4 @ 2400 MT/s providing up to 192 GB memory capacity. Intel Turbo Boost Technology, Intel Hyper-Threading Technology, Intel AVX-512(1x 512-bit FMA), 48 lanes PCIe 3.0, standard RAS supported.
- Bronze – 3200 Series - Supports 6-Channel DDR4 @ 2133 MT/s providing up to 192GB memory capacity. Intel AVX-512(1x 512-bit FMA), 48 lanes PCIe 3.0, standard RAS supported.

Intel First Generation Xeon® Scalable Processors							
Intel Xeon Models	CPU Frequency	Cores	L3 Cache	Power	UPI	DDR4	Memory per socket
Gold Processors							
Gold 5122 Processor	3.6 GHz	4	16.50 MB	105W	2 @ 10.4 GT/s	2666 MT/s	192 GB
Gold 5120 Processor	2.2 GHz	14	19.25 MB	105W	2 @ 10.4 GT/s	2400 MT/s	192 GB
Silver Processors							
Silver 4112 Processor	2.6 GHz	4	8.25 MB	85W	2 @ 9.6 GT/s	2400 MT/s	192 GB
Silver 4110 Processor	2.1 GHz	8	11.00 MB	85W	2 @ 9.6 GT/s	2400 MT/s	192 GB
Silver 4108 Processor	1.8 GHz	8	11.00 MB	85W	2 @ 9.6 GT/s	2400 MT/s	192 GB
Bronze Processors							
Bronze 3106 Processor	1.7 GHz	8	11.00 MB	85W	2 @ 9.6 GT/s	2133 MT/s	192 GB
Bronze 3104 Processor	1.7 GHz	6	11.00 MB	85W	2 @ 9.6 GT/s	2133 MT/s	192 GB



Standard Features

Notes:

- Gold – 5100 Series - Supports 6-Channel DDR4 @ 2400 MT/s of SKU 5120 and @2666 MT/s of SKU 5122 providing up to 192 GB memory capacity. Intel Turbo Boost Technology, Intel Hyper-Threading Technology, Intel AVX-512(1x 512-bit FMA) (SKU 5122 supports 2x 512 bit FMA), 48 lanes PCIe 3.0, advanced RAS supported.
- Silver – 4100 Series -6-Channel DDR4 @ 2400 MT/s providing up to 192 GB memory capacity. Intel Turbo Boost Technology, Intel Hyper-Threading Technology, Intel AVX-512(1x 512-bit FMA), 48 lanes PCIe 3.0, standard RAS supported.
- Bronze – 3100 Series - Supports 6-Channel DDR4 @ 2133 MT/s providing up to 192GB memory capacity. Intel AVX-512(1x 512-bit FMA), 48 lanes PCIe 3.0, standard RAS supported.

Chipset

Intel C621 Chipset

Notes: For more information regarding Intel® chipsets, please see the following

URL: <http://www.intel.com/products/server/chipsets/>

On System Management Chipset

HPE iLO 5 ASIC

Notes: Read and learn more in the [iLO QuickSpecs](#).

Memory

Type	HPE SmartMemory Memory DDR4 Registered (RDIMM)
DIMM Slots Available	6 6 DIMM slots per processor, 6 channels per processor, 1 DIMM per channel
Maximum capacity (RDIMM)	192 GB 6 x 32 GB RDIMM @ 2933 MT/s

Notes:

- LRDIMM is not qualified by this server. This server does not support mixing LRDIMMs and RDIMMs. Attempting to mix any combination of these DIMMs can cause the server to halt during BIOS installation. All memory installed in the server must be of the same type.
- The maximum memory speed is a function of the memory type, memory configuration, and processor model.

Memory Protection

For details on the HPE Server Memory Options RAS feature, visit: <http://www.hpe.com/docs/memory-ras-feature>.

Expansion Slots

Slots #	Technology	Bus Width	Connector Width	Slot Form Factor	Notes
5	PCIe 3.0	X4	X8	Full-height, half-length slot	PCH
4	PCIe 3.0	X16	X16	Full-height, full-length slot	Proc 1
3	PCIe 3.0	X8	X8	Full-height, half-length slot	Proc 1
2	PCIe 3.0	X4	X8	Full-height, half-length slot	Proc 1
1	PCIe 3.0	X16	X16	Full-height, ¾ length (up to 9.5") Slot	Proc 1

Notes:

- Bus Width Indicates the number of physical electrical lanes running to the connector.
- Although the Speed of slot is designed for 32Gb/s, the actual running speed will be lower than it was designed. Hence Slot 2 and Slot 5 will be least recommended for usage.



Standard Features

Storage Controllers

The Gen10 controller naming framework has been updated to simplify identification as depicted below. For a more detailed breakout of the available Gen10 Smart Array controllers visit the [HPE Smart Array Gen10 Controllers Data Sheet](#). One of the following depending on model.

Software RAID

- HPE Smart Array S100i SR Gen10 SW RAID

Notes:

- HPE Smart Array S100i SR Gen10 SW RAID will operate in UEFI mode only. For legacy support an additional controller will be needed, and for CTO orders please also select the Legacy mode settings part, 758959-B22.
- HPE Smart Array S100i SR Gen10 SW RAID is off by default and must be enabled. For enabling please select HPE FIO Enable Smart Array SW RAID (784308-B21).
- HPE Smart Array S100i SR Gen10 Software RAID, supporting 6Gb/s SATA, is an entry-level solution for supporting RAID 0, 1, 5, and 10 on SATA drives connected to the embedded SATA ports on the system board.
- The S100i supports 10 ports as 2 additional ports are leveraged to support the M.2 option.
- S100i Software RAID only supports Windows. For Linux users, HPE offers a solution that uses in-distro open-source software to create a two-disk RAID 1 boot volume. For more information visit: <https://downloads.linux.hpe.com/SDR/project/lrbb/>
- Customers using Linux and VMware can use the embedded SATA ports in AHCI mode. In AHCI mode S100i Software RAID is not enabled.
- For more information on HPE's server operating systems and virtualization software, please visit: <http://www.hpe.com/info/ossupport>

Essential RAID Controller

- HPE Smart Array E208i-p SR Gen10 Controller
- HPE Smart Array E208e-p SR Gen10 Controller

Performance RAID Controller

- HPE Smart Array P408i-p SR Gen10 Controller
- HPE Smart Array P408e-p SR Gen10 Controller

Notes: Performance RAID Controllers require the HPE Smart Storage Battery (P01367-B21-B21) which is sold separately.

Internal Storage Devices

One of the following depending on model

Optical Drive

- Optional SATA 9.5mm DVD-ROM Optical Drive
- Optional SATA 9.5mm DVD RW Optical Drive

Notes: Optical is optional in BTO models.

Hard Drives

- None ship standard

Hard Drive Bays

- Up to 8 Non-hot plug SATA 3.5-inch drives
- 4 Hot plug LFF SAS/SATA HDD bays; upgradable to 8
- 8 Hot plug SFF SAS/SATA HDD bays; upgradable to 16

Notes:

- Mixing drive cage types is not allowed.
 - All Pre-configured Models come populated with hard drive blanks installed. The 4LFF configurations includes 3 blanks and 8SFF includes 7 blanks. Additional hard drive blanks can be ordered using either P/N 807878-B21 for the HPE LFF HDD Blank Kit or P/N 666987-B21 for the HPE SFF HDD Blank Kit. These part numbers for single HDD blanks below are also provided should you require replacement HDD blanks for your server.
 - NHP SATA is limited to S100i controller.
-



Standard Features

Maximum Internal Storage

Drives	Capacity	Configuration
Hot Plug LFF SAS	96 TB	8 x 12 TB
Hot Plug LFF SATA	96 TB	8 x 12 TB
Hot Plug SFF SAS	38.4 TB	16 x 2.4 TB
Hot Plug SFF SATA	32 TB	16 x 2 TB
Non Hot Plug LFF SATA	32 TB	8 x 4 TB
Hot Plug LFF SATA SSD	30.72 TB	8 x 3.84 TB
Hot Plug SFF SAS SSD	61.44 TB	16 x 3.84 TB
Hot Plug SFF SATA SSD	61.44 TB	16 x 3.84 TB

Power Supply

- HPE ML110 Gen10 350W ATX Power Supply Kit
- HPE ML110 Gen10 550W ATX Power Supply Kit

Notes: ATX power supply will not support redundant fan option.

HPE Entry-Level Power Supplies provide lower-cost options for customers trying to balance their need for enterprise class efficiency and reliability while maintaining lowest possible hardware costs. All Entry-Level power supply options have been designed specifically for HPE ProLiant Gen10 Essential Series servers.

The HPE 550W ATX Power Supply is the standard, non-redundant AC power supply option for most HPE ProLiant Gen10 Essential servers. It features Gold-level (90%) certified power efficiency with a set of features optimized for the Gen10 Essential-series rack and tower servers.

- HPE 500W Flex Slot Platinum Hot Plug Low Halogen Power Supply Kit
- HPE 800W Flex Slot Platinum Hot Plug Low Halogen Power Supply Kit

Notes:

- Flex Slot Platinum power supplies support power efficiency of up to 94% and include a standard C-14 power inlet connector.
- The 500W and 800W Flex Slot Platinum Hot Plug Low Halogen Power Supply Kit requires the RPS Enablement Kit.
- The RPS Enablement kit will support two power supplies.

HPE Flexible Slot (Flex Slot) Power Supplies share a common electrical and physical design that allows for hot plug, tool-less installation into HPE ProLiant Gen10 Performance Servers. Flex Slot power supplies are certified for high-efficiency operation and offer multiple power output options, allowing users to "right-size" a power supply for specific server configurations. This flexibility helps to reduce power waste, lower overall energy costs, and avoid "trapped" power capacity in the data center.

This jumper cord is also included with each standard AC power supply option kit. If a different power cord is required, please check the [ProLiant Power Cables](#) web page.

To review the power requirements for your selected system, please use the [HPE Power Advisor Tool](#).

For information on power specifications and technical content visit [HPE Server power supplies](#).

Interfaces

VGA port	1 standard (at system rear)
Network RJ-45 (Ethernet)	2 standard (at system rear)
Serial	1 optional (at system rear)
iLO Management Port	1 standard (at system rear)
iLO Service Port	1 standard (at system front)
MicroSD Slot	1 standard (at system internal) Notes: The MicroSD slot is not hot-pluggable, please power down server before installation or removal.
USB 3.0	5 (2 front, 2 rear, 1 internal)
USB 2.0	3 (2 rear, 1 internal)



Standard Features

Operating Systems and Virtualization Software Support for ProLiant Servers

- Microsoft Windows Server
- Red Hat Enterprise Linux (RHEL)
- SUSE Linux Enterprise Server (SLES)
- VMware
- **ClearOS**

HPE and ClearCenter will help you lower the cost of building on-premise solutions without sacrificing security and ease of use. HPE ProLiant servers with ClearOS give you a simple, secure, and affordable operating system with an intuitive web-based graphical user interface that provides a cloud-like experience on-premise, and an Application Marketplace with over 100 apps and growing. Whether you're starting out or scaling, you decide what applications you need and pay as you grow.

Notes: ClearOS allows you to build a fully functional server that is just right for you at no upfront cost.

For more information on ClearOS, please visit <http://www.hpe.com/servers/clearos>.

- **CentOS**

CentOS not directly supported / Community Supported (Based on RHEL so RHEL testing and enablement applicable to CentOS) CentOS 6.9 / CentOS 7.3, 7.4.

For more information on Hewlett Packard Enterprise Certified and Supported ProLiant Servers for OS and Virtualization Software and latest listing of software drivers available for your server <http://h20566.www2.hpe.com/portal/site/hpsc/public/psi/home?sp4ts.oid=1010026818>.

Graphics

Integrated Video Standard

- Video modes up to 1920 x 1200 @60Hz (32 bpp)
- 16MB Video Memory

HPE iLO 5 on system management memory

- 32 MB Flash
- 4 Gbit DDR 3 with ECC protection

HPE Server UEFI/Legacy ROM

Unified Extensible Firmware Interface (UEFI) is an industry standard that provides better manageability and more secured configuration than the legacy ROM while interacting with your server at boot time. HPE ProLiant Gen10 servers have a UEFI Class 2 implementation and support both UEFI Mode (default) and Legacy BIOS Mode.

Notes: The UEFI System Utilities tool is analogous to the HPE ROM-Based Setup Utility (RBSU) of legacy BIOS.

For more information, please visit <http://www.hpe.com/servers/uefi>.

UEFI enables numerous new capabilities specific to HPE ProLiant servers such as:

- Secure Boot and Secure Start enable for enhanced security
- Operating system specific functionality
- Support for > 2.2 TB (using GPT) boot drives
- USB 3.0 Stack
- Embedded UEFI Shell
- Mass Configuration Deployment Tool using iLO RESTful API that is Redfish API Conformant
- PXE boot support for IPv6 networks
- Workload Profiles for simple performance optimization



Standard Features

UEFI Boot Mode only:

- TPM 2.0 Support
- iSCSI Software Initiator Support.
- HTTP/HTTPs Boot support as a PXE alternative.
- Boot support for option cards that only support a UEFI option ROM

Notes:

- For UEFI Boot Mode, boot environment and OS image installations should be configured properly to support UEFI.
- UEFI FIO Setting (758959-B22) can be selected to configure the system in Legacy mode in the factory for your HPE ProLiant Gen10 Server.

Industry Standard Compliance

- ACPI 6.1 Compliant
- PCIe 3.0 Compliant
- WOL Support
- Microsoft® Logo certifications
- Novell Certified
- PXE Support
- VGA Port
- USB 3.0 Compliant
- USB 2.0 Compliant
- Energy Star
- SMBIOS 3.1
- UEFI 2.6
- Redfish API
- IPMI 2.0
- Secure Digital 2.0
- Advanced Encryption Standard (AES)
- Triple Data Encryption Standard (3DES)
- SNMP v3
- TLS 1.2
- DMTF Systems Management Architecture for Server Hardware Command Line Protocol (SMASH CLP)
- Active Directory v1.0
- ASHRAE A3

Notes: For additional technical thermal details regarding ambient temperatures, humidity and features support please visit: <http://www.hpe.com/servers/ashrae>.

- UEFI (Unified Extensible Firmware Interface Forum)
Notes: UEFI is the default for the ML110 Gen10. Legacy mode can be selected in the field or as a CTO option (758959-B22).
- European Compliance Union (EU) eco-design regulations for server and storage products, known as Lot 9, go into effect on March 1st, 2020. Among other requirements, for servers this directive establishes power thresholds for idle state, as well as efficiency and performance in active state which vary among configurations. HPE ProLiant Gen10 servers are compliant with Lot9 requirements. For more information regarding HPE Lot 9 conformance, please visit: <https://www.hpe.com/us/en/about/environment/msds-specs-more.html>



Standard Features

Embedded Management

HPE Integrated Lights-Out (HPE iLO)

Monitor your servers for ongoing management, service alerting, reporting and remote management with HPE iLO.

Learn more at <http://www.hpe.com/info/ilo>.

- HPE iLO Common Password FIO Setting (supported on ALL Servers)
- HPE iLO Common Password FIO Setting P08040-B21

Notes:

- Replaces iLO default randomized password by an HPE defined common password. HPE highly recommends changing this password immediately after the initial onboarding process.
- Customers who want to choose their own custom iLO default password should use the HPE Factory Express Integration Services

UEFI

Configure and boot your servers securely with industry standard Unified Extensible Firmware Interface (UEFI).

Learn more at <http://www.hpe.com/servers/uefi>.

Intelligent Provisioning

Hassle free server and OS provisioning for 1 or more servers with Intelligent Provisioning. Learn more at

<http://www.hpe.com/servers/intelligentprovisioning>.

iLO RESTful API

iLO RESTful API is Redfish API conformance and offers simplified server management automation such as configuration and maintenance tasks based on modern industry standards. Learn more at <http://www.hpe.com/info/restfulapi>.

Server Utilities

Active Health System

The HPE Active Health System (AHS) is an essential component of the iLO management portfolio that provides continuous, proactive health monitoring of HPE servers. Learn more at <http://www.hpe.com/servers/ahs>.

Active Health System Viewer

Use the Active Health System Viewer, a web-based portal, to easily read AHS logs and speed problem resolution with HPE self-repair recommendations, to learn more visit: <http://www.hpe.com/servers/ahsv>.

Smart Update

Keep your servers up to date with the HPE Smart Update solution by using Smart Update Manager (SUM) to optimize the firmware and driver updates of the Service Pack for ProLiant (SPP). Learn more at

<https://www.hpe.com/us/en/product-catalog/detail/pip.smart-update-manager-sum.5182020.html>

iLO Amplifier Pack

Designed for large enterprise and service provider environments with hundreds of HPE servers, the iLO Amplifier Pack is a free, downloadable open virtual application (OVA) that delivers the power to discover, inventory and update Gen8, Gen9 and Gen10 HPE servers at unmatched speed and scale. Use with an iLO Advanced License to unlock full capabilities. Learn more at <http://www.hpe.com/servers/iLOamplifierpack>.

HPE iLO Mobile Application

Enables the ability to access, deploy, and manage your server anytime from anywhere from select smartphones and mobile devices. For additional information please visit: <http://www.hpe.com/info/ilo/mobileapp>.



Standard Features

RESTful Interface Tool

RESTful Interface tool (iLOREST) is a single scripting tool to provision using iLO RESTful API to discover and deploy servers at scale. Learn more at <http://www.hpe.com/info/resttool>.

Scripting Tools

Provision one to many servers using your own scripts to discover and deploy with Scripting Tool (STK) for Windows and Linux or Scripting Tools for Windows PowerShell. Learn more at <http://www.hpe.com/servers/powershell>.

HPE OneView Standard

HPE OneView Standard can be used for inventory, health monitoring, alerting, and reporting without additional fees. It can monitor multiple HPE server generations. The user interface is similar to the HPE OneView Advanced version, but the software-defined functionality is not available. Learn more at <http://www.hpe.com/info/oneview>.

HPE Systems Insight Manager (HPE SIM)

Ideal for environments already using HPE SIM, it allows you to monitor the health of your HPE ProLiant Servers and HPE Integrity Servers. Also provides you with basic support for non-HPE servers. HPE SIM also integrates with Smart Update Manager to provide quick and seamless firmware updates. Learn more at <http://www.hpe.com/info/hpesim>.

Security

- UEFI Secure Boot and Secure Start support
- Immutable Silicon Root of Trust
- FIPS 140-2 validation
- Common Criteria certification
- Configurable for PCI DSS compliance
- Ability to rollback firmware
- Secure erase of NAND/User data
- TPM (Trusted Platform Module) 1.2 option
- TPM (Trusted Platform Module) 2.0 option

Warranty

This product is covered by a global limited warranty and supported by HPE Services and a worldwide network of Hewlett Packard Enterprise Authorized Channel Partners resellers. Hardware diagnostic support and repair is available for three years from date of purchase. Support for software and initial setup is available for 90 days from date of purchase. Enhancements to warranty services are available through HPE Pointnext operational services or customized service agreements. Hard drives have either a one year or three year warranty; refer to the specific hard drive QuickSpecs for details.

Notes: Server Warranty includes 3-Year Parts, 3-Year Labor, 3-Year Onsite support with next business day response.

Exceptions may apply to certain regions or countries. Warranty repairs may be accomplished through the use of Customer Self Repair (CSR) parts. These parts fall into two categories: 1) Mandatory CSR parts are designed for easy replacement. A travel and labor charge will result when customers decline to replace a Mandatory CSR part; 2) Optional CSR parts are also designed for easy replacement but may involve added complexity; 3) Non CSR parts must be serviced by a trained authorized service engineer. Customers may choose to have Hewlett Packard Enterprise replace Optional CSR parts at no charge. Additional information regarding worldwide limited warranty and technical support is available at: <http://h17007.www1.hpe.com/us/en/enterprise/servers/warranty/>.



Optional Features

Server Management

HPE iLO Advanced

HPE iLO Advanced licenses offer smart remote functionality without compromise, for all HPE ProLiant servers. The license includes the full integrated remote console, virtual keyboard, video, and mouse (KVM), multi-user collaboration, console record and replay, and GUI-based and scripted virtual media and virtual folders. You can also activate the enhanced security and power management functionality. Learn more about HPE iLO Advanced at <http://www.hpe.com/servers/iloadvanced>

HPE OneView Advanced

HPE OneView brings a new level of automation to infrastructure management by taking a template driven approach to provisioning, updating, and integrating compute, storage, and networking infrastructure. It provides full-featured licenses which can be purchased for managing Gen8, Gen9 and Gen10 servers. To learn more visit <http://www.hpe.com/info/oneview>

HPE iLO Advanced Premium Security Edition

HPE iLO Advanced Premium Security Edition for iLO 5 includes iLO Advanced License plus high-end security modes, unique security capabilities, like Automatic FW recovery; Runtime FW verification, and Secure erase. Learn more about HPE iLO Advanced Premium Security Edition at: <http://www.hpe.com/servers/ilopremium>.

One Config Simple (SCE)

SCE is a guided self-service tool to help sales and non-technical people provide customers with initial configurations in 3 to 5 minutes. You may then send the configuration on for configuration help, or use in your existing ordering processes. If you require "custom" rack configuration or configuration for products not available in SCE, please contact Hewlett Packard Enterprise Customer Business Center or an Authorized Partner for assistance. <https://h22174.www2.hpe.com/SimplifiedConfig/Welcome>

HPE InfoSight for Servers

HPE InfoSight for Servers combines the cloud-based machine learning of InfoSight with the health and performance monitoring of Active Health System (AHS) and iLO to optimize performance and predict and prevent problems. The end result is an intelligent environment that modernizes IT operations and enhances the support experience by predicting and preventing the infrastructure issues that lead to application disruptions, wasted IT staff time and missed business opportunities.

Learn more at <https://www.hpe.com/servers/infosight>



Service and Support

HPE Pointnext Service

Achieve maximum return from your IT investment

Get the expertise you need at every step of the IT journey with **HPE Pointnext Services**. We help you lower your risks and costs using proven best practices, automation and methodologies that have been tested and refined by HPE experts through thousands of implementations and deployments globally. With Advisory Services, we focus on your business outcomes and goals, partnering with you to design your transformation and build a roadmap tuned to your unique challenges.

Connect your devices:

Unlock all of the benefits of your technology investment by connecting your products to Hewlett Packard Enterprise. By connecting, you will receive 24x7 monitoring, pre-failure alerts, automatic call logging, and automatic parts dispatch. HPE Proactive Care Service and HPE Datacenter Care Service customers will also benefit from proactive activities to help prevent issues and increase optimization. All of these benefits are already available to you with your server storage and networking products, securely connected to HPE support. Learn more about getting connected at <http://www.hpe.com/services/getconnected>.

Recommended Services

HPE Proactive Care* with 6 hour call-to-repair commitment, three year Support Service

HPE Proactive Care gives customers an enhanced call experience. When your products are connected to HPE, Proactive Care helps prevent problems and maintains IT stability by utilizing personalized proactive reports with recommendations and advice. This Service combines three years' proactive reporting and advice with our highest level of hardware support – the HPE 24x7, six hour hardware call-to-repair. Hewlett Packard Enterprise is the only leading manufacturer who makes this level of coverage available as a standard service offering for your most valuable servers. This service also includes collaborative software support for Independent Software Vendors (ISVs), (Red Hat, VMWare, Microsoft, etc.) running on your HPE servers.

<https://www.hpe.com/h20195/v2/GetPDF.aspx/4AA3-8855ENW.pdf>

HPE Proactive Care* with 24x7 coverage, three year Support Service

HPE Proactive Care gives customers an enhanced call experience. When your products are connected to HPE, Proactive Care helps prevent problems and maintains IT stability by utilizing personalized proactive reports with recommendations and advice. This Service combines three years proactive reporting and advice with our 24x7 coverage, four hour hardware response time when there is a problem. This service also includes collaborative software support for Independent Software Vendors (ISVs), (Red Hat, VMWare, Microsoft, etc.) running on your HPE servers. <https://www.hpe.com/h20195/v2/GetPDF.aspx/4AA3-8855ENW.pdf>

HPE Proactive Care* - Next Business Day service, three year Support Service

HPE Proactive Care gives customers an enhanced call experience. When your products are connected to HPE, Proactive Care helps prevent problems and maintains IT stability by utilizing personalized proactive reports with recommendations and advice. This service combines three years of Hardware Support where an Hewlett Packard Enterprise authorized representative will arrive at the Customer's site during the onsite coverage window to begin hardware maintenance service the next coverage day after the service request has been logged. This service also includes collaborative software support for Independent Software Vendors (ISVs), (Red Hat, VMWare, Microsoft, etc.) running on your HPE servers.

<https://www.hpe.com/h20195/v2/GetPDF.aspx/4AA3-8855ENW.pdf>

Notes:*HPE Proactive Care and HPE Proactive Care Advanced require that the customer connect their devices to make the most of these services and receive all the deliverables.

HPE Foundation Care CTR, three-year Support Service

HPE Foundation Care Call-To-Repair Service connects you to HPE 24 hours a day, seven days a week for assistance on resolving issues -this includes our highest level commitment to repair hardware within six hours after opening your case and respond to software questions within two hours. Hewlett Packard Enterprise is the only leading manufacturer who makes this level of coverage available as a standard service offering for your most valuable servers. In addition, Collaborative software support is included and provides troubleshooting assistance on industry leading software running on your server. Simplify your support experience and make HPE your first call to help resolve hardware or software problems.

<https://www.hpe.com/h20195/V2/GetDocument.aspx?docname=4AA4-8876ENW&cc=us&lc=en>



Service and Support

HPE Foundation Care 24x7, three-year Support Service

HPE Foundation Care 24x7 gives you access to HPE 24 hours a day, seven days a week for assistance on resolving issues. This service includes need based Hardware onsite response within four hours. In addition, collaborative software support is included in this service that provides troubleshooting assistance on industry leading software running on your HPE server. Simplify your support experience and make HPE your first call to help resolve hardware or software problems.

<https://www.hpe.com/h20195/V2/GetDocument.aspx?docname=4AA4-8876ENW&cc=us&lc=en>

HPE Foundation Care NBD, three-year Support Service

HPE Foundation Care Next Business Day connects you to HPE during business hours for assistance on resolving issues – This service features need based next business day hardware onsite response and software call back within two hours. In addition, Collaborative software support and provides troubleshooting assistance on industry leading software running on your HPE server. Simplify your support experience and make HPE your first call to help resolve hardware or software problems.

<https://www.hpe.com/h20195/V2/GetDocument.aspx?docname=4AA4-8876ENW&cc=us&lc=en>

Other related Services

HPE Server Hardware Installation

Provides for the basic hardware installation of HPE branded servers, storage devices and networking options to assist you in bringing your new hardware into operation in a timely and professional manner.

<https://www.hpe.com/h20195/V2/GetPDF.aspx/5981-9356ENW.pdf>

HPE Installation and Startup Service

Provides for the installation of your HPE hardware according to product specifications including options. The HPE service delivery technician will connect the product to a LAN as appropriate and enable remote support to allow for automatic case creation for hardware failures. Installation and start up services also includes the installation of one supported operating system type (Windows® or Linux).

<https://www.hpe.com/h20195/V2/GetPDF.aspx/5982-7572ENW.pdf>

HPE Factory Express for Servers and storage

HPE Factory Express offers configuration, customization, integration and deployment services for HPE servers and storage products. Customers can choose how their factory solutions are built, tested, integrated, shipped and deployed. Factory Express offers service packages for simple configuration, racking, installation, complex configuration and design services as well as individual factory services, such as image loading, asset tagging, and custom packaging.

<https://www.hpe.com/us/en/services/factory-express.html>

HPE Service Credits

HPE Service Credits offers flexible services and technical skills to meet your changing IT demands. With a menu of service that is tailored to suit your needs, you get additional resources and specialist skills to help you maintain peak performance of your IT. Offered as annual credits, you can plan your budgets while proactively responding to your dynamic business.

<https://h20195.www2.hpe.com/v2/GetDocument.aspx?docname=4aa6-4611enw>

HPE Education Services

Keep your IT staff trained making sure they have the right skills to deliver on your business outcomes. Book on a class today and learn how to get the most from your technology investment. <http://www.hpe.com/ww/learn>



Service and Support

HPE Support Center

The HPE Support Center is a personalized online support portal with access to information, tools and experts to support HPE business products. Submit support cases online, chat with HPE experts, access support resources or collaborate with peers.

Learn more <http://www.hpe.com/support/hpesc>.

HPE's Support Center Mobile App* allows you to resolve issues yourself or quickly connect to an agent for live support. Now, you can get access to personalized IT support anywhere, anytime.

HPE Insight Remote Support and HPE Support Center are available at no additional cost with a HPE warranty, HPE Support Service or HPE contractual support agreement.

Notes:*HPE Support Center Mobile App is subject to local availability.

For more information: <http://www.hpe.com/services>.

Notes: HPE ProLiant ML110 Gen10 Server is covered under the HPE Service Contract applied to the HPE ProLiant Server. No separate HPE support services need to be purchased.

Warranty and Support Services will extend to include HPE options configured with your server or storage device. The price of support service is not impacted by configuration details. HPE sourced options that are compatible with your product will be covered under your server support at the same level of coverage allowing you to upgrade freely. Installation for HPE options is available as needed. To keep support costs low for everyone, some high value options will require additional support. Additional support is only required on select high value workload accelerators, fibre switches, InfiniBand and UPS batteries over 12KVA. See the specific high value options that require additional support [here](#).

Parts and Materials

Hewlett Packard Enterprise will provide HPE-supported replacement parts and materials necessary to maintain the covered hardware product in operating condition, including parts and materials for available and recommended engineering improvements.

Parts and components that have reached their maximum supported lifetime and/or the maximum usage limitations as set forth in the manufacturer's operating manual, product quick-specs, or the technical product data sheet will not be provided, repaired, or replaced as part of these services.

The defective media retention service feature option applies only to Disk or eligible SSD/Flash Drives replaced by Hewlett Packard Enterprise due to malfunction.



Pre Configured Models

SMB Models			
	Entry Models	Entry Models	Performance Models
SKU Number	P10806-xxx	P21438-421	P10811-xxx
Model Name	HPE ProLiant ML110 Gen10 3204 1.9GHz 6-core 1P 8GB-R S100i 4LFF-NHP 350W PS Server	HPE ProLiant ML110 Gen10 3204 1.9GHz 6-core 1P 16GB-R S100i 4LFF-NHP 550W PS Server	HPE ProLiant ML110 Gen10 3204 1.9GHz 6-core 1P 16GB-R S100i 4LFF 550W PS Server
Processor	3204 (6-Core, 1.9 GHz, 85W)	3204 (6-Core, 1.9 GHz, 85W)	3204 (6-Core, 1.9 GHz, 85W)
Number of Processors	One processor		
Memory	8 GB RDIMM DDR4 2933 MT/s (1x 8 GB) Notes: The maximum memory speed for Intel 3204 processor is 2133 MT/s.	16 GB RDIMM DDR4 2933 MT/s (1x 16 GB) Notes: The maximum memory speed for Intel 3204 processor is 2133 MT/s.	16 GB RDIMM DDR4 2933 MT/s (1x 16 GB) Notes: The maximum memory speed for Intel 3204 processor is 2133 MT/s.
Network Controller	Embedded 2-Port 1GbE HPE Ethernet 1Gb 2-port 332i Adapter		
Storage Controller	Embedded SW RAID with 10 SATA ports		
Hard Drive	None ship as standard		
Internal Storage	4 LFF HDD Bays (Non Hot Plug)	4 LFF HDD Bays (Non Hot Plug)	4 LFF HDD Bays (Hot Plug)
Optical Drive Bay	1; (Optional: DVD-ROM, DVD-RW)		
Optical Drive	None ship as standard		
PCI-Express Slots	5 PCIe 3.0 slots		
Power Supply	(1) 350W ATX Power Supply	(1) 550W ATX Power Supply	(1) 550W ATX Power Supply
Fans	2 non-hot plug, non-redundant		
Management	HPE iLO Standard with Intelligent Provisioning (embedded), HPE OneView Standard (requires download); HPE iLO Advanced(optional), HPE iLO Advanced Premium Security Edition (optional)		
Energy Star	2.1 certified		
Form Factor	Tower (4.5U)		
Warranty	3-year parts, 3-year labor, 3-year onsite support with next business day response.		



Pre Configured Models

	Entry Models	Performance Models	
SKU Number	P21439-xxx	P10812-xxx	P21440-xxx
Model Name	HPE ProLiant ML110 Gen10 3206R 1.9GHz 8-core 1P 16GB-R S100i 4LFF 550W PS Server	HPE ProLiant ML110 Gen10 4208 2.1GHz 8-core 1P 16GB-R S100i 4LFF 550W PS Server	HPE ProLiant ML110 Gen10 4208 2.1GHz 8-core 1P 16GB-R S100i 8SFF 800W RPS Server
Processor	3206R (8-Core, 1.9 GHz, 85W)	4208 (8-Core, 2.1 GHz, 85W)	4208 (8-Core, 2.1 GHz, 85W)
Number of Processors	One processor		
Memory	16 GB RDIMM DDR4 2933 MT/s (1x 16 GB) Notes: The maximum memory speed for Intel 3206R processor is 2133 MT/s.	16 GB RDIMM DDR4 2933 MT/s (1x 16 GB) Notes: The maximum memory speed for Intel 4208 processor is 2400 MT/s.	16 GB RDIMM DDR4 2933 MT/s (1x 16 GB) Notes: The maximum memory speed for Intel 4208 processor is 2400 MT/s.
Network Controller	Embedded 2-Port 1GbE HPE Ethernet 1Gb 2-port 332i Adapter		
Storage Controller	Embedded SW RAID with 10 SATA ports		
Hard Drive	None ship as standard		
Internal Storage	4 LFF HDD Bays (Hot Plug)	4 LFF HDD Bays (Hot Plug)	8 SFF HDD Bays (Hot Plug)
Optical Drive Bay	1; (Optional: DVD-ROM, DVD-RW)		
Optical Drive	None ship as standard		
PCI-Express Slots	5 PCIe 3.0 slots		
Power Supply	(1) 550W ATX Power Supply	(1) 550W ATX Power Supply	(1) 800W RPS
Fans	2 non-hot plug, non-redundant		
Management	HPE iLO Standard with Intelligent Provisioning (embedded), HPE OneView Standard (requires download); HPE iLO Advanced(optional), HPE iLO Advanced Premium Security Edition (optional)		
Energy Star	2.1 certified		
Form Factor	Tower (4.5U)		
Warranty	3-year parts, 3-year labor, 3-year onsite support with next business day response.		



Pre Configured Models

	Performance Models
SKU Number	P10813-xxx
Model Name	HPE ProLiant ML110 Gen10 4210 2.2GHz 10-core 1P 16GB-R P408i-p 8SFF 800W RPS Server
Processor	4210 (10-Core, 2.2 GHz, 85W)
Number of Processors	One processor
Memory	16 GB RDIMM DDR4 2933 MT/s (1x 16 GB) Notes: The maximum memory speed for Intel 4210 processor is 2400 MT/s.
Network Controller	Embedded 2-Port 1GbE HPE Ethernet 1Gb 2-port 332i Adapter
Storage Controller	HPE Smart Array P408i-p SR Gen10 Controller
Hard Drive	None ship as standard
Internal Storage	8 SFF HDD Bays (Hot Plug)
Optical Drive Bay	1; (Optional: DVD-ROM, DVD-RW)
Optical Drive	None ship as standard
PCI-Express Slots	5 PCIe 3.0 slots
Power Supply	(1) 800W RPS
Fans	2 non-hot plug, non-redundant
Management	HPE iLO Standard with Intelligent Provisioning (embedded), HPE OneView Standard (requires download); HPE iLO Advanced/HPE iLO Advanced Premium Security Edition (optional)
Energy Star	2.1 certified
Form Factor	Tower (4.5U)
Operation System	ClearOS/VM Installer (USB) Notes: ClearOS, an easy to use OS with an application marketplace, allows you to build a fully functional server that is just right for you at no upfront cost. To learn more on what you can do, please visit http://www.hpe.com/servers/clearos .
Warranty	3-year parts, 3-year labor, 3-year onsite support with next business day response.

	Performance Models
SKU Number	P21449-xxx
Model Name	HPE ProLiant ML110 Gen10 4210R 2.4GHz 10-core 1P 16GB-R P408i-p 8SFF 800W RPS Server
Processor	4210R (10-Core, 2.4 GHz, 100W)
Number of Processors	One processor
Memory	16 GB RDIMM DDR4 2933 MT/s (1x 16 GB) Notes: The maximum memory speed for Intel 4210R processor is 2400 MT/s.
Network Controller	Embedded 2-Port 1GbE HPE Ethernet 1Gb 2-port 332i Adapter
Storage Controller	HPE Smart Array P408i-p SR Gen10 Controller
Hard Drive	None ship as standard
Internal Storage	8 SFF HDD Bays (Hot Plug)
Optical Drive Bay	1; (Optional: DVD-ROM, DVD-RW)
Optical Drive	None ship as standard
PCI-Express Slots	5 PCIe 3.0 slots
Power Supply	(1) 800W RPS
Fans	2 non-hot plug, non-redundant
Management	HPE iLO Standard with Intelligent Provisioning (embedded), HPE OneView Standard (requires download); HPE iLO Advanced/HPE iLO Advanced Premium Security Edition (optional)
Energy Star	2.1 certified
Form Factor	Tower (4.5U)
Operation System	ClearOS/VM Installer (USB) Notes: ClearOS, an easy to use OS with an application marketplace, allows you to build a fully functional server that is just right for you at no upfront cost. To learn more on what you can do, please visit http://www.hpe.com/servers/clearos .
Warranty	3-year parts, 3-year labor, 3-year onsite support with next business day response.



Pre Configured Models

Country Code Key

xxx = 001 NA and LAC

xxx = 421 EU and UK

xxx = 371 AP

xxx = 291 Japan

Important:

P10806-421 is going to go obsolete on February 29, 2020 to cope with the regional regulatory changes per the new ErP Lot 9 requirements for EU/EMEA. Rest of the P10806-xxx will continue to ship in their pre-defined regions/countries outside of EMEA. Refer to the country code summary in the back of this section.

For HPE channel partners/distributors, OEM partners, or any end customers that have the need to re ship these server units into EU after March 1, 2020, please review relevant ErP Lot 9/CE regulatory requirements to ensure your solutions are Lot 9 compliant and meet all local/regional requirements. For detail about ErP Lot 9, please

visit <https://www.hpe.com/us/en/about/environment/msds-specs-more.html>.

Notes: P10806-421, HPE ML110 Gen10 3204 1P 8G 4LFF NHP Svr with the 350W ATX PS which is affected by lot 9 power efficiency requirement.

	Entry Models	Performance Models	
SKU Number	P03684-xxx	P03685-xxx	P03686-xxx
Model Name	HPE ProLiant ML110 Gen10 3104 1.7GHz 6-core 1P 8GB-R S100i 4LFF NHP SATA 350W PS Entry Server	HPE ProLiant ML110 Gen10 3106 1.7GHz 8-core 1P 16GB-R S100i 4LFF Hot Plug 550W PS Perf Server	HPE ProLiant ML110 Gen10 4108 1.8GHz 8-core 1P 16GB-R S100i 4LFF Hot Plug 550W PS Perf Server
Processor	3104 (6-Core, 1.7 GHz, 85W)	3106 (8-Core, 1.7 GHz, 85W)	4108 (8-Core, 1.8 GHz, 85W)
Number of Processors	One processor		
Memory	8 GB RDIMM DDR4 2666 MT/s (1x 8 GB) Notes: The maximum memory speed for Intel 3104 processor is 2133 MT/s.	16 GB RDIMM DDR4 2666 MT/s (1x 16 GB) Notes: The maximum memory speed for Intel 3106 processor is 2133 MT/s.	16 GB RDIMM DDR4 2666 MT/s (1x 16 GB) Notes: The maximum memory speed for Intel 4108 processor is 2400 MT/s.
Network Controller	Embedded 2-Port 1GbE HPE Ethernet 1Gb 2-port 332i Adapter		
Storage Controller	Embedded SW RAID with 10 SATA ports		
Hard Drive	None ship as standard		
Internal Storage	4 LFF HDD Bays (Non Hot Plug)	4 LFF HDD Bays (Hot Plug)	4 LFF HDD Bays (Hot Plug)
Optical Drive Bay	1; (Optional: DVD-ROM, DVD-RW)		
Optical Drive	1 DVD-RW	None ship as standard	
PCI-Express Slots	5 PCIe 3.0 slots		
Power Supply	(1) 350W ATX Power Supply	(1) 550W ATX Power Supply	(1) 550W ATX Power Supply
Fans	2 non-hot plug, non-redundant		
Management	HPE iLO Standard with Intelligent Provisioning (embedded), HPE OneView Standard (requires download); HPE iLO Advanced(optional), HPE iLO Advanced Premium Security Edition (optional)		
Energy Star	2.1 certified		
Form Factor	Tower (4.5U)		
Warranty	3-year parts, 3-year labor, 3-year onsite support with next business day response.		



Pre Configured Models

Solution Models	
SKU Number	P03687-xxx
Model Name	ProLiant ML110 Gen10 / 8 SFF Hot Plug / 4.5U Tower / 4110 Xeon-S / 16Gb (1 x 16GB) / Smart Arrray S100i SATA / 2 x 1GB NIC / 800W Power Supply / 3-3-3
Processor	4110 (8-Core, 2.1 GHz, 85W)
Number of Processors	One processor
Memory	16 GB RDIMM DDR4 2666 MT/s (1x 16 GB) Notes: The maximum memory speed for Intel 4108 processor is 2400 MT/s.
Network Controller	Embedded 2-Port 1GbE HPE Ethernet 1Gb 2-port 332i Adapter
Storage Controller	Embedded SW RAID with 10 SATA ports
Hard Drive	None ship as standard
Internal Storage	8 SFF HDD Bays (Hot Plug)
Optical Drive Bay	1; (Optional: DVD-ROM, DVD-RW)
Optical Drive	None ship as standard
PCI-Express Slots	5 PCIe 3.0 slots
Power Supply	(1) 800W RPS
Fans	2 non-hot plug, non-redundant
Management	HPE iLO Standard with Intelligent Provisioning (embedded), HPE OneView Standard (requires download); HPE iLO Advanced/HPE iLO Advanced Premium Security Edition (optional)
Energy Star	2.1 certified
Form Factor	Tower (4.5U)
Operation System	ClearOS/VM Installer (USB) Notes: ClearOS, an easy to use OS with an application marketplace, allows you to build a fully functional server that is just right for you at no upfront cost. To learn more on what you can do, please visit http://www.hpe.com/servers/clearos .
Warranty	3-year parts, 3-year labor, 3-year onsite support with next business day response.

Country Code Key

xxx = S01 NA and LAC

xxx = 425 EU and UK

xxx = 375 AP

xxx = 291 Japan



Configuration Information

This section lists some of the steps required to configure a Factory Integrated Model. To ensure only valid configurations are ordered, Hewlett Packard Enterprise recommends the use of an HPE approved configurator. Contact your local sales representative for information on configurable product offerings and requirements

- Factory Integrated Models must start with a CTO Server.
- FIO indicates that this option is only available as a factory installable option.
- All Factory Integrated Models will be populated with sufficient hard drive blanks based on the number of initial hard drives ordered with the server.
- Some options may not be integrated at the factory. Contact your local sales representative for additional information.
- European Compliance Union (EU) eco-design regulations for server and storage products, known as Lot 9, go into effect on March 1st, 2020. Among other requirements, for servers this directive establishes power thresholds for idle state, as well as efficiency and performance in active state which vary among configurations. HPE ProLiant Gen10 servers are compliant with Lot9 requirements. For more information regarding HPE Lot 9 conformance, please visit: <https://www.hpe.com/us/en/about/environment/msds-specs-more.html>

Step 1: Base Configuration (choose one of the following configurable models)

CTO Server	HPE ProLiant ML110 Gen10 4LFF Non Hot Plug Configure-to-order Server	HPE ProLiant ML110 Gen10 4LFF Configure-to-order Server	HPE ProLiant ML110 Gen10 8SFF Configure-to-order Server
SKU Number	872305-B21	872307-B21	872309-B21
Processor	Not included as standard		
DIMM Slots	6 DIMM slots for RDIMM DDR4 Memory		
Storage Controller	Embedded SW RAID with 10 SATA ports, or choice of HPE PCIe Smart Array controller		
PCIe	5 PCIe 3.0 Slots		
Drive Cage - included	4 LFF Non Hot Plug	4 LFF Hot Plug	8 SFF Hot Plug
Network Controller	Embedded 2-Port 1GbE HPE Ethernet 1Gb 2-port 332i Adapter		
Fans	2 non-hot plug, non-redundant		
Management	HPE iLO Standard with Intelligent Provisioning (embedded), HPE OneView Standard (requires download); HPE iLO Advanced(optional), HPE iLO Advanced Premium Security Edition (optional)		
USB	2 front, 2 internal, 4 rear		

Step 2: Choose Required Options - (Only one of the following from each list unless otherwise noted)

Step 2a: Choose Processors

Processor Option Kits - - Intel Second Generation Xeon® Scalable Processors

	SKU
Intel Xeon-Gold 5222 (3.8GHz/4-core/105W) FIO Processor Kit for HPE ProLiant ML110 Gen10.	P10983-L21
Intel Xeon-Gold 5218N (2.3GHz/16-core/110W) FIO Processor Kit for HPE ProLiant ML110 Gen10.	P12037-L21
Intel Xeon-Gold 5215 (2.5GHz/10-core/85W) FIO Processor Kit for HPE ProLiant ML110 Gen10.	P10982-L21
Intel Xeon-Silver 4216 (2.1GHz/16-core/100W) FIO Processor Kit for HPE ProLiant ML110 Gen10.	P10981-L21
Intel Xeon-Silver 4215 (2.5GHz/8-core/85W) FIO Processor Kit for HPE ProLiant ML110 Gen10	P10980-L21
Intel Xeon-Silver 4214R (2.4GHz/12-core/100W) FIO Processor Kit for HPE ProLiant ML110 Gen10	P18733-L21
Intel Xeon-Silver 4214 (2.2GHz/12-core/85W) FIO Processor Kit for HPE ProLiant ML110 Gen10	P10979-L21
Intel Xeon-Silver 4210R (2.4GHz/10-core/100W) FIO Processor Kit for HPE ProLiant ML110 Gen10	P18732-L21
Intel Xeon-Silver 4210 (2.2GHz/10-core/85W) FIO Processor Kit for HPE ProLiant ML110 Gen10	P10978-L21
Intel Xeon-Silver 4208 (2.1GHz/8-core/85W) FIO Processor Kit for HPE ProLiant ML110 Gen10.	P10977-L21
Intel Xeon-Bronze 3206R (1.9GHz/8-core/85W) FIO Processor Kit for HPE ProLiant ML110 Gen10	P18730-L21
Intel Xeon-Bronze 3204 (1.9GHz/6-core/85W) FIO Processor Kit for HPE ProLiant ML110 Gen10.	P10976-L21

Configuration Information

Step 2b: Choose Memory Options

Please select one or more memory from below.

For new Gen10 memory population rule whitepaper and optimal memory performance guidelines, please go to:

<https://www.hpe.com/docs/memory-population-rules>

For Gen10 memory speed table, please go to: <https://www.hpe.com/docs/memory-speed-table>

For memory Reliability, Accessibility, Serviceability (RAS) features whitepaper like Gen10 Fast Fault Tolerance and legacy mirrored memory feature etc. please go to: <http://www.hpe.com/docs/memory-ras-feature>

Notes: The maximum memory speed is a function of the memory type, memory configuration, and processor model.

Memory – for the Second Generation Intel Xeon® Scalable Processors

HPE 8GB (1x8GB) Single Rank x8 DDR4-2933 CAS-21-21-21 Registered Smart Memory Kit	P00918-B21
HPE 16GB (1x16GB) Single Rank x4 DDR4-2933 CAS-21-21-21 Registered Smart Memory Kit	P00920-B21
HPE 16GB (1x16GB) Dual Rank x8 DDR4-2933 CAS-21-21-21 Registered Smart Memory Kit	P00922-B21
HPE 32GB (1x32GB) Dual Rank x4 DDR4-2933 CAS-21-21-21 Registered Smart Memory Kit	P00924-B21

Memory – for the First Generation Intel Xeon® Scalable Processors

HPE 8GB (1x8GB) Single Rank x8 DDR4-2666 CAS-19-19-19 Registered Smart Memory Kit	815097-B21
HPE 16GB (1x16GB) Single Rank x4 DDR4-2666 CAS-19-19-19 Registered Smart Memory Kit	815098-B21
HPE 32GB (1x32GB) Dual Rank x4 DDR4-2666 CAS-19-19-19 Registered Smart Memory Kit	815100-B21

Step 2c: Choose Power Supplies

Select one or two power supplies from below.

Notes:

- Prior to selecting a power supply option, it is highly recommended that you review your server configuration in the HPE Power Advisor tool to determine the right size power supply for your server configuration. The HPE Power Advisor is located at: <http://www.hpe.com/info/hppoweradvisor>.
- By RPS Enablement Kit power options, mixing of power supplies in the same RPS enablement kit is not supported. All power supplies must be of the same input voltage, output rating, and efficiency rating. If non-matching power supplies are installed, you may receive an error message and/or experience operational issues with your server.

Power Supplies

HPE ML110 Gen10 350W ATX FIO Power Supply Kit	867876-B21
HPE ML110 Gen10 550W ATX Power Supply Kit	874009-B21
HPE ML110 Gen10 Redundant Power Supply Enablement Kit	867875-B21
HPE 500W Flex Slot Platinum Hot Plug Low Halogen Power Supply Kit	865408-B21
HPE 800W Flex Slot Platinum Hot Plug Low Halogen Power Supply Kit	865414-B21

Step 3: Choose Additional Factory Integratable Options

One of the following from each list may be selected if desired at time of factory integration

HPE Legacy FIO Mode Setting	758959-B22
-----------------------------	------------

Notes: UEFI is the default, this FIO part can be used for CTO to enable Legacy mode.

Step 4: Choose Additional Options for factory integration from Core and Additional Options Sections below



Core Options

Some options may not be integrated at the factory. To ensure only valid configurations are ordered, Hewlett Packard Enterprise recommends the use of an HPE approved configurator. Contact your local sales representative for additional information.

Notes: the **Cabling Matrix** can help to explain the cable routing for each option:

HPE Unique Options

HPE ML110 Gen10 4LFF Drive Backplane Cage Kit 869491-B21

Notes: The 4 LFF hot-plug drive cage can be installed in both box 1 and box 2. Follow the same installation procedure.

HPE ML110 Gen10 4LFF Non Hot Plug Drive Cage Kit 874008-B21

Notes: The 4 LFF Non hot-plug drive cage can be installed in both box 1 and box 2. Follow the same installation procedure.

HPE ML110 Gen10 8SFF Drive Backplane Cage Kit 874007-B21

Notes: The 8SFF hot-plug drive cage can be installed in both box 1 and box 2. Follow the same installation procedure.

HPE ML110 Gen10 12Gb SAS Expander Card Kit P11359-B21

Notes:

- Add this SAS Expander option kit to upgrade your ML110 Gen10 SFF system pre-configured with either P408i-p or E208i-p, to support 16 SFF drives.
- This option is not supported with LFF configurations.

HPE ML110 Gen10 Redundant Power Supply Enablement Kit 867875-B21

Notes: This kit is also required to support an optional redundant fan kit.

HPE ML110 Gen10 Redundant Fan with 4 Fans Kit 869489-B21

Notes: When one of the following scenarios occurs, the server requires a Redundant Fan with a 800W Redundant Power Supply to be installed.

- When a second HDD cage is installed and the SAS HDDs are running at 15K RPM.
- When a SAS SSD is installed.
- If one fan fails, the system will be required to continue operating with a Redundant Fan. This condition is indicated by a flashing amber Health LED.
- When the system requirements are to meet the A3 extended operating environment.

HPE ML110 Gen10 550W ATX Power Supply Kit 874009-B21

Notes: Prior to selecting a power supply option, it is highly recommended that you review your server configuration in the HPE Power Advisor tool to determine the right size power supply for your server configuration. The HPE Power Advisor is located at: <http://www.hpe.com/info/hppoweradvisor>

HPE ML110 Gen10 Serial Port Kit 874010-B21

Memory Selection

To streamline the configuration process for HPE ProLiant Gen10 servers and to provide the best product availability, HPE recommends memory from the list located here: <http://www.hpe.com/servers/servermemoryconfigurator>. Best product availability is limited to US, Canada, and Latin America at this time.

HPE DDR4 SmartMemory

SmartMemory – for the Second Generation Intel Xeon® Scalable Processors

HPE 8GB (1x8GB) Single Rank x8 DDR4-2933 CAS-21-21-21 Registered Smart Memory Kit P00918-B21

HPE 16GB (1x16GB) Single Rank x4 DDR4-2933 CAS-21-21-21 Registered Smart Memory Kit P00920-B21

HPE 16GB (1x16GB) Dual Rank x8 DDR4-2933 CAS-21-21-21 Registered Smart Memory Kit P00922-B21

HPE 32GB (1x32GB) Dual Rank x4 DDR4-2933 CAS-21-21-21 Registered Smart Memory Kit P00924-B21

SmartMemory – for the First Generation Intel Xeon® Scalable Processors

HPE 8GB (1x8GB) Single Rank x8 DDR4-2666 CAS-19-19-19 Registered Smart Memory Kit 815097-B21

HPE 16GB (1x16GB) Single Rank x4 DDR4-2666 CAS-19-19-19 Registered Smart Memory Kit 815098-B21



Core Options

HPE 32GB (1x32GB) Dual Rank x4 DDR4-2666 CAS-19-19-19 Registered Smart Memory Kit 815100-B21

Notes:

- Memory DIMM availability with a server platform is dependent upon completion of certification testing.
- The maximum memory speed is a function of the memory type, memory configuration, and processor model.

HPE Optical Drives

Optical Drives

HPE 9.5mm SATA DVD-ROM Optical Drive 726536-B21

HPE 9.5mm SATA DVD-RW Optical Drive 726537-B21

HPE Drives

Enterprise - 12G SAS - SFF Drives

HPE 300GB SAS 12G Enterprise 15K SFF (2.5in) SC 3yr Wty Digitally Signed Firmware HDD 870753-B21

HPE 300GB SAS 12G Enterprise 10K SFF (2.5in) SC 3yr Wty Digitally Signed Firmware HDD 872475-B21

HPE 600GB SAS 12G Enterprise 15K SFF (2.5in) SC 3yr Wty Digitally Signed Firmware HDD 870757-B21

HPE 600GB SAS 12G Enterprise 10K SFF (2.5in) SC 3yr Wty Digitally Signed Firmware HDD 872477-B21

HPE 900GB SAS 12G Enterprise 15K SFF (2.5in) SC 3yr Wty Digitally Signed Firmware HDD 870759-B21

HPE 1.2TB SAS 12G Enterprise 10K SFF (2.5in) SC 3yr Wty Digitally Signed Firmware HDD 872479-B21

HPE 1.8TB SAS 12G Enterprise 10K SFF (2.5in) SC 3yr Wty 512e Digitally Signed Firmware HDD 872481-B21

HPE 2.4TB SAS 12G Enterprise 10K SFF (2.5in) SC 3yr Wty 512e Digitally Signed Firmware HDD 881457-B21

Midline - 12G SAS - SFF Drives

HPE 1TB SAS 12G Midline 7.2K SFF (2.5in) SC 1yr Wty Digitally Signed Firmware HDD 832514-B21

HPE 2TB SAS 12G Midline 7.2K SFF (2.5in) SC 1yr Wty 512e HDD 765466-B21

Midline - 12G SAS - LFF Drives

HPE 2TB SAS 12G Midline 7.2K LFF (3.5in) LP 1yr Wty Digitally Signed Firmware HDD 833926-B21

HPE 4TB SAS 12G Midline 7.2K LFF (3.5in) LP 1yr Wty Digitally Signed Firmware HDD 833928-B21

HPE 8TB SAS 12G Midline 7.2K LFF (3.5in) LP 1yr Wty 512e Digitally Signed Firmware HDD 834031-B21

HPE 12TB SAS 12G Midline 7.2K LFF (3.5in) LP 1yr Wty Helium 512e Digitally Signed Firmware HDD 881781-B21

HPE 18TB SAS 7.2K LFF LP 512e ISE HDD P37669-B21

Midline - 6G SATA - SFF Drives

HPE 1TB SATA 6G Midline 7.2K SFF (2.5in) SC 1yr Wty Digitally Signed Firmware HDD 655710-B21

HPE 2TB SATA 6G Midline 7.2K SFF (2.5in) SC 1yr Wty 512e Digitally Signed Firmware HDD 765455-B21

Midline - 6G SATA - LFF Drives

HPE 1TB SATA 6G Midline 7.2K LFF (3.5in) LP 1yr Wty Digitally Signed Firmware HDD 861686-B21

HPE 1TB SATA 6G Midline 7.2K LFF (3.5in) RW 1yr Wty HDD 801882-B21

HPE 2TB SATA 6G Midline 7.2K LFF (3.5in) LP 1yr Wty Digitally Signed Firmware HDD 861681-B21

HPE 4TB SATA 6G Midline 7.2K LFF (3.5in) LP 1yr Wty Digitally Signed Firmware HDD 861683-B21

HPE 4TB SATA 6G Midline 7.2K LFF (3.5in) RW 1yr Wty HDD 801888-B21

HPE 6TB SATA 6G Midline 7.2K LFF (3.5in) LP 1yr Wty 512e HDD 861742-B21

HPE 8TB SATA 6G Midline 7.2K LFF (3.5in) LP 1yr Wty 512e Digitally Signed Firmware HDD 834028-B21

HPE 12TB SATA 6G Midline 7.2K LFF (3.5in) LP 1yr Wty Helium 512e Digitally Signed Firmware HDD 881787-B21

HPE 18TB SATA 7.2K LFF LP 512e ISE HDD P37678-B21



Core Options

SSD Selection

To streamline the configuration process for HPE ProLiant Gen10 servers and to provide the best product availability, HPE recommends SSDs from the list located here: <http://www.hpe.com/products/recommend>

Write Intensive – 12G SAS - SFF - Solid State Drives

HPE 400GB SAS WI SFF SC PM6 SSD	P26295-B21
HPE 400GB SAS 12G Write Intensive SFF SC SS540 SSD	P21125-B21
HPE 400GB SAS 12G Write Intensive SFF SC PM5 SSD	P04541-B21
HPE 800GB SAS WI SFF SC PM6 SSD	P26372-B21
HPE 800GB SAS 12G Write Intensive SFF SC SS540 SSD	P21127-B21
HPE 800GB SAS 12G Write Intensive SFF SC PM5 SSD	P04543-B21
HPE 1.6TB SAS WI SFF SC PM6 SSD	P26376-B21
HPE 1.6TB SAS 12G Write Intensive SFF SC SS540 SSD	P21129-B21
HPE 1.6TB SAS 12G Write Intensive SFF SC PM5 SSD	P04545-B21

Read Intensive - 6G SATA - SFF - Solid State Drives

HPE 240GB SATA 6G Read Intensive SFF SC PM883 SSD	P04556-B21
HPE 480GB SATA 6G Read Intensive SFF SC PM883 SSD	P04560-B21
HPE 960GB SATA 6G Read Intensive SFF SC PM883 SSD	P04564-B21
HPE 1.92TB SATA 6G Read Intensive SFF SC PM883 SSD	P04566-B21
HPE 3.84TB SATA 6G Read Intensive SFF SC PM883 SSD	P04570-B21
HPE 240GB SATA 6G Read Intensive SFF SC S4510 SSD	P05924-B21
HPE 480GB SATA 6G Read Intensive SFF SC S4510 SSD	P05928-B21
HPE 960GB SATA 6G Read Intensive SFF SC S4510 SSD	P05932-B21
HPE 1.92TB SATA 6G Read Intensive SFF SC S4510 SSD	P05938-B21
HPE 3.84TB SATA 6G Read Intensive SFF SC S4510 SSD	P05946-B21
HPE 240GB SATA 6G Read Intensive SFF SC Multi Vendor SSD	P18420-B21
HPE 480GB SATA 6G Read Intensive SFF SC Multi Vendor SSD	P18422-B21
HPE 960GB SATA 6G Read Intensive SFF SC Multi Vendor SSD	P18424-B21
HPE 1.92TB SATA 6G Read Intensive SFF SC Multi Vendor SSD	P18426-B21
HPE 3.84TB SATA 6G Read Intensive SFF SC Multi Vendor SSD	P18428-B21
HPE 7.68TB SATA 6G Read Intensive SFF SC Multi Vendor SSD	P18430-B21

Read Intensive - 6G SATA - LFF - Solid State Drives

HPE 960GB SATA 6G Read Intensive LFF LPC PM883 SSD	P09691-B21
--	------------

Read Intensive - 12G SAS - SFF - Solid State Drives

HPE 960GB SAS 12G Read Intensive SFF SC PM5 SSD	P04517-B21
HPE 1.92TB SAS 12G Read Intensive SFF SC PM5 SSD	P04519-B21
HPE 3.84TB SAS 12G Read Intensive SFF SC PM5 SSD	P04521-B21
HPE 7.68TB SAS 12G Read Intensive SFF SC PM5 SSD	P04523-B21
HPE 960GB SAS 12G Read Intensive SFF SC Value SAS RM5 SSD	P10440-B21

Read Intensive - 12G SAS - SFF - Solid State Drives

HPE 960GB SAS RI SFF SC PM6 SSD	P26285-B21
HPE 960GB SAS 12G Read Intensive SFF SC SS540 SSD	P21139-B21
HPE 960GB SAS 12G Read Intensive SFF SC PM1643a SSD	P19903-B21
HPE 1.92TB SAS RI SFF SC PM6 SSD	P26302-B21
HPE 1.92TB SAS 12G Read Intensive SFF SC SS540 SSD	P21141-B21



Core Options

HPE 1.92TB SAS 12G Read Intensive SFF SC Value SAS RM5 SSD	P10442-B21
HPE 1.92TB SAS 12G Read Intensive SFF SC PM1643a SSD	P19905-B21
HPE 3.84TB SAS RI SFF SC PM6 SSD	P26306-B21
HPE 3.84TB SAS 12G Read Intensive SFF SC SS540 SSD	P21143-B21
HPE 3.84TB SAS 12G Read Intensive SFF SC Value SAS RM5 SSD	P10444-B21
HPE 3.84TB SAS 12G Read Intensive SFF SC PM1643a SSD	P19907-B21
HPE 7.68TB SAS RI SFF SC PM6 SSD	P26310-B21
HPE 7.68TB SAS 12G Read Intensive SFF SC SS540 SSD	P21145-B21
HPE 7.68TB SAS 12G Read Intensive SFF SC Value SAS RM5 SSD	P10446-B21
HPE 7.68TB SAS 12G Read Intensive SFF SC PM1643a SSD	P19909-B21
HPE 15.3TB SAS RI SFF SC PM6 SSD	P26314-B21
HPE 15.3TB SAS 12G Read Intensive SFF SC SS540 SSD	P21147-B21
Mixed Use - 12G SAS - SFF - Solid State Drives	
HPE 400GB SAS 12G Mixed Use SFF (2.5in) SC 3yr Wty Digitally Signed Firmware SSD	P04525-B21
HPE 800GB SAS MU SFF SC PM6 SSD	P26290-B21
HPE 800GB SAS 12G Mixed Use SFF SC SS540 SSD	P21131-B21
HPE 800GB SAS 12G Mixed Use SFF SC PM5 SSD	P04527-B21
HPE 800GB SAS 12G Mixed Use SFF SC PM5 SSD	P04527-B21
HPE 800GB SAS 12G Mixed Use SFF SC PM1645a SSD	P19913-B21
HPE 960GB SAS 12G Mixed Use SFF SC Value SAS RM5 SSD	P10448-B21
HPE 1.6TB SAS MU SFF SC PM6 SSD	P26354-B21
HPE 1.6TB SAS 12G Mixed Use SFF SC SS540 SSD	P21133-B21
HPE 1.6TB SAS 12G Mixed Use SFF (2.5in) SC 3yr Wty Digitally Signed Firmware SSD	P09092-B21
HPE 1.6TB SAS 12G Mixed Use SFF SC PM1645a SSD	P19915-B21
HPE 3.2TB SAS MU SFF SC PM6 SSD	P26358-B21
HPE 3.2TB SAS 12G Mixed Use SFF SC SS540 SSD	P21135-B21
HPE 3.2TB SAS 12G Mixed Use SFF SC PM5 SSD	P04537-B21
HPE 3.2TB SAS 12G Mixed Use SFF (2.5in) SC 3yr Wty Digitally Signed Firmware SSD	P09094-B21
HPE 3.2TB SAS 12G Mixed Use SFF SC PM1645a SSD	P19917-B21
HPE 6.4TB SAS MU SFF SC PM6 SSD	P26362-B21
HPE 6.4TB SAS 12G Mixed Use SFF SC SS540 SSD	P21137-B21
HPE 6.4TB SAS 12G Mixed Use SFF SC PM5 SSD	P04539-B21
HPE 6.4TB SAS 12G Mixed Use SFF (2.5in) SC 3yr Wty Digitally Signed Firmware SSD	P09096-B21
HPE 6.4TB SAS 12G Mixed Use SFF SC PM1645a SSD	P19919-B21
HPE 1.92TB SAS 12G Mixed Use SFF SC Value SAS RM5 SSD	P10454-B21
HPE 3.84TB SAS 12G Mixed Use SFF SC Value SAS RM5 SSD	P10460-B21
Mixed Use - 12G SAS - LFF - Solid State Drives	
HPE 1.6TB SAS 12G Mixed Use LFF LPC PM5 SSD	P04535-B21
HPE 960GB SAS 12G Mixed Use LFF LPC Value SAS RM5 SSD	P10452-B21
Mixed Use - 6G SATA - SFF - Solid State Drives	
HPE 480GB SATA 6G Mixed Use SFF SC S4610 SSD	P05976-B21
HPE 480GB SATA 6G Mixed Use SFF SC SM883 SSD	P09712-B21
HPE 480GB SATA 6G Mixed Use SFF SC SE5031 SSD	P13658-B21
HPE 480GB SATA 6G Mixed Use SFF SC Multi Vendor SSD	P18432-B21



Core Options

HPE 960GB SATA 6G Mixed Use SFF SC S4610 SSD	P05980-B21
HPE 960GB SATA 6G Mixed Use SFF SC SM883 SSD	P09716-B21
HPE 960GB SATA 6G Mixed Use SFF SC SE5031 SSD	P13660-B21
HPE 960GB SATA 6G Mixed Use SFF SC Multi Vendor SSD	P18434-B21
HPE 1.92TB SATA 6G Mixed Use SFF SC S4610 SSD	P05986-B21
HPE 1.92TB SATA 6G Mixed Use SFF SC SM883 SSD	P09722-B21
HPE 1.92TB SATA 6G Mixed Use SFF SC SE5031 SSD	P13662-B21
HPE 1.92TB SATA 6G Mixed Use SFF SC Multi Vendor SSD	P18436-B21
HPE 3.84TB SATA 6G Mixed Use SFF SC S4610 SSD	P05994-B21
HPE 3.84TB SATA 6G Mixed Use SFF RW SE5031 SSD	P13664-B21
HPE 3.84TB SATA 6G Mixed Use SFF SC Multi Vendor SSD	P18438-B21
HPE 3.84TB SATA 6G Mixed Use SFF SC SM883 SSD	P21517-B21

Hard Drive Blank Kits

HPE Gen9 LFF HDD Spade Blank Kit	807878-B21
HPE Small Form Factor Hard Drive Blank Kit	666987-B21

Hard Drive Kits

HPE Universal SATA 6G AIC HHHL M.2 SSD Enablement Kit	878783-B21
HPE NS204i-p NVMe PCIe3 OS Boot Device	P12965-B21

GPGPU Information

Part number	Card	Qty support	TDP	PCIe speed	ML110 configuration			
					8SFF	4LFF	16 SFF	8 LFF
Q0V77A	NVIDIA Quadro P2000 GPU Module	2	75W	Gen3	35C	35C	35C	35C
Q1P47C	AMD Radeon Pro WX2100 GPU Module	2	35W	Gen3	35C	35C	35C	35C
R3K70C	NVIDIA Quadro P1000 GPU Module	2	47W	Gen3	35C	35C	35C	35C
R2U55C	NVIDIA Quadro P2200 GPU Module	2	75W	Gen3	35C	35C	35C	35C
R1F95C	NVIDIA Quadro RTX4000 GPU Module	1	125W	Gen3	35C	35C	35C	35C

Notes:

- Please see the [HPE Power Advisor](http://www.hpe.com/info/hppoweradvisor) for estimated power consumption of your individual system configuration prior to installing GPUs. The HPE Power Advisor is located at: <http://www.hpe.com/info/hppoweradvisor>.
- Only the above listed Graphics cards are HPE standard supported options in this server.

HPE Computation and Graphics Accelerators

NVIDIA Quadro P1000 Graphics Accelerator for HPE	R3K70C
NVIDIA Quadro P2200 Graphics Accelerator for HPE	R2U55C
NVIDIA Quadro RTX 4000 Graphics Accelerator for HPE	R1F95C
HPE ML110 Gen10 GPU FHFL Holder Kit	P11529-B21

Notes:

- When Quadro RTX4000 Graphics Accelerator is installed, the server requires a GPU Full-length Holder Kit to be installed.
- Please update system Firmware to latest version for supporting Graphics cards.



Core Options

HPE Networking

1 Gigabit Ethernet adapters

HPE Ethernet 1Gb 4-port BASE-T BCM5719 Adapter	647594-B21
HPE Ethernet 1Gb 4-port BASE-T I350-T4V2 Adapter	811546-B21
HPE Ethernet 1Gb 2-port BASE-T I350-T2V2 Adapter	652497-B21
HPE Ethernet 1Gb 2-port BASE-T BCM5720 Adapter	615732-B21

10 Gigabit Ethernet adapters

HPE Ethernet 10Gb 2-port SFP+ 57810S Adapter	652503-B21
HPE Ethernet 10Gb 2-port BASE-T 57810S Adapter	656596-B21
HPE Ethernet 10Gb 2-port BASE-T BCM57416 Adapter	813661-B21
HPE Ethernet 10Gb 2-port BASE-T X550-AT2 Adapter	817738-B21
HPE Ethernet 10Gb 2-port 562SFP+ Adapter	727055-B21

Notes:

- The ML110 Gen10 ships with 2x 1 Gb Embedded.
- A minimum of two Gigabytes (2 GB) of server memory is required per each adapter.
- Direct Attach Cable (DAC) for copper environments or fiber transceivers and cables for fiber-optic environments must be purchased separately. Please see the related NIC QuickSpecs for Technical Specifications and additional information: <http://www.hpe.com/us/en/product-catalog/servers/server-adapters.hits-12.html>.

HPE Power Supplies

HPE ML110 Gen10 550W ATX Power Supply Kit	874009-B21
HPE ML110 Gen10 Redundant Power Supply Enablement Kit	867875-B21
HPE 500W Flex Slot Platinum Hot Plug Low Halogen Power Supply Kit	865408-B21
HPE 800W Flex Slot Platinum Hot Plug Low Halogen Power Supply Kit	865414-B21

Notes: Flex Slot Platinum power supplies support power efficiency of up to 94% and include a standard C-14 power inlet connector.

HPE Cooling Options

HPE ML110 Gen10 Redundant Fan with 4 Fans Kit	869489-B21
---	------------

Notes: When one of the following scenarios occurs, the server requires a Redundant Fan with a 800W Redundant Power Supply to be installed.

- When a second HDD cage is installed and the SAS HDDs are running at 15K RPM.
- When a SAS SSD is installed.
- If one fan fails, the system will be required to continue operating with a Redundant Fan. This condition is indicated by a flashing amber Health LED.
- When the system requirements are to meet the A3 extended operating environment.



Additional Options

Embedded Management

HPE iLO Advanced

HPE iLO Advanced Electronic License with 1yr Support on iLO Licensed Features	E6U59ABE
HPE iLO Advanced 1-server License with 1yr Support on iLO Licensed Features	512485-B21
HPE iLO Advanced Flexible Quantity License with 1yr Support on iLO Licensed Features	512486-B21
HPE iLO Advanced AKA Tracking License with 1yr Support on iLO Licensed Features	512487-B21
HPE iLO Advanced Electronic License with 3yr Support on iLO Licensed Features	E6U64ABE
HPE iLO Advanced 1-server License with 3yr Support on iLO Licensed Features	BD505A
HPE iLO Advanced Flexible Quantity License with 3yr Support on iLO Licensed Features	BD506A
HPE iLO Advanced AKA Tracking License with 3yr Support on iLO Licensed Features	BD507A

HPE Security

HPE Trusted Platform Module 2.0 Gen10 Option	864279-B21
--	------------

Notes:

- HPE Trusted Platform Module 2.0 option works with Gen10 servers with UEFI Mode not Legacy Mode. It is not compatible with HPE ProLiant Gen8 servers or earlier generation variants.
- HPE server systems can have a TPM module (of any type) installed only once. It cannot be replaced with any other TPM module.
- There is a FIO setting to allow this TPM module to operate in a TPM 1.2 mode (872108-B21).

HPE Smart Array Controllers

The Gen10 controller naming framework has been updated to simplify identification as depicted below. For a more detailed breakout of the available Gen10 Smart Array controllers visit the

[HPE Smart Array Gen10 Controllers Data Sheet](#).

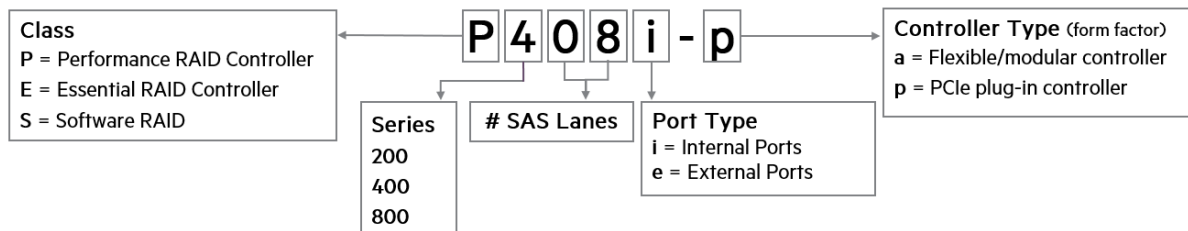

Notes:

- HPE 96W Smart Storage Battery (up to 20 Devices) with 260mm Cable Kit.
- All performance RAID controllers are supported by the HPE Smart Storage Battery (P01367-B21), which supports multiple devices and is sold separately.

Performance RAID Controllers

HPE Smart Array P408i-p SR Gen10 (8 Internal Lanes/2GB Cache) 12G SAS PCIe Plug-in Controller	830824-B21
HPE Smart Array P408e-p SR Gen10 (8 External Lanes/4GB Cache) 12G SAS PCIe Plug-in Controller	804405-B21

Essential RAID Controllers

HPE Smart Array E208e-p SR Gen10 (8 External Lanes/No Cache) 12G SAS PCIe Plug-in Controller	804398-B21
HPE Smart Array E208i-p SR Gen10 (8 Internal Lanes/No Cache) 12G SAS PCIe Plug-in Controller	804394-B21

HPE Boot Controllers

HPE NS204i-p x2 Lanes NVMe PCIe3 x8 OS Boot Device	P12965-B21
--	------------



Additional Options

HPE Cable Options and SAS Expander Kit

HPE ML110 Gen10 12Gb SAS Expander Card Kit P11359-B21

Notes:

- Add this SAS Expander option kit to upgrade your ML110 Gen10 SFF system pre-configured with either P408i-p or E208i-p, to support 16 SFF drives.
- This option is not supported with LFF configurations.

Optional Software

HPE Smart Array SR Secure Encryption (Data at Rest Encryption/per Server Entitlement) E-LTU Q2F26AAE

HPE Smart Array SR SmartCache (Single Key/Single Server) LTU D7S26A

HPE Smart Array SR SmartCache (Single Key/Multiple Servers) LTU D7S27A

HPE Smart Array SR SmartCache (Single Key/Multiple Servers) E-LTU D7S27AAE

Notes: SmartCache is offered on HPE Smart Array performance RAID controllers.

Optional Upgrades

HPE Smart Storage Hybrid Capacitor with 260mm Cable Kit P02381-B21

HPE 96W Smart Storage Lithium-ion Battery with 260mm Cable Kit P01367-B21

Notes:

- Provides backup power for multiple HPE Smart Array controllers or other devices. Is required with performance RAID controllers. This product replaces 875242-B21.
- A Battery holder is required: HPE Gen9 Smart Storage Battery Holder Kit 786710-B21.

HPE Tape Backup

Notes:

- For the complete range of tape drives, autoloaders, libraries and media see <https://www.hpe.com/us/en/storage/storeever-tape-storage.html>
- For hardware and software compatibility of Hewlett Packard Enterprise tape backup products <http://www.hpe.com/storage/BURACompatibility>.

HPE RDX Products

HPE RDX External Docking Station C8S07B

HPE RDX 4TB Removable Disk Cartridge Q2048A

HPE RDX 2TB Removable Disk Cartridge Q2046A

HPE RDX 3TB Removable Disk Cartridge Q2047A

HPE RDX 500GB Removable Disk Cartridge Q2042A

HPE RDX 1TB Removable Disk Cartridge Q2044A

HPE USB and SD Options

HPE Enterprise Mainstream Flash Media Kits for Memory Cards

HPE 32GB microSD RAID 1 USB Boot Drive P21868-B21

HPE 32GB microSD Flash Memory Card 700139-B21

Rail Kits

HPE ML Gen10 Tower to Rack Conversion Kit with Sliding Rail Rack Shelf and Cable Management Arm 874578-B21

Notes: Easy install rack rail tray which takes up 1U height in a standard rack facility. This kit is supported in both ML350 and ML110 Gen10 for tower to rack conversion.



Additional Options

HPE Support Services

HPE 3 Year Foundation Care 24x7 ML110 Gen10 Service	H9CH9E
HPE 3 Year Foundation Care 24x7 with DMR ML110 Gen10 Service	H9CJ0E
HPE 3 Year Foundation Care 24x7 with CDMR ML110 Gen10 Service	H9CJ1E
HPE 3 Year Proactive Care 24x7 ML110 Gen10 Service	H9CJ2E
HPE 3 Year Proactive Care 24x7 with DMR ML110 Gen10 Service	H9CJ3E
HPE 3 Year Proactive Care 24x7 with CDMR ML110 Gen10 Service	H9CJ4E
HPE Installation ML310e/ML110 Service	U6G21E
HPE Installation and Startup ML310e Service	U6G23E

Notes: For a full listing of support services available for this server, please visit <https://ssc.hpe.com/>



Memory

Memory Population guidelines

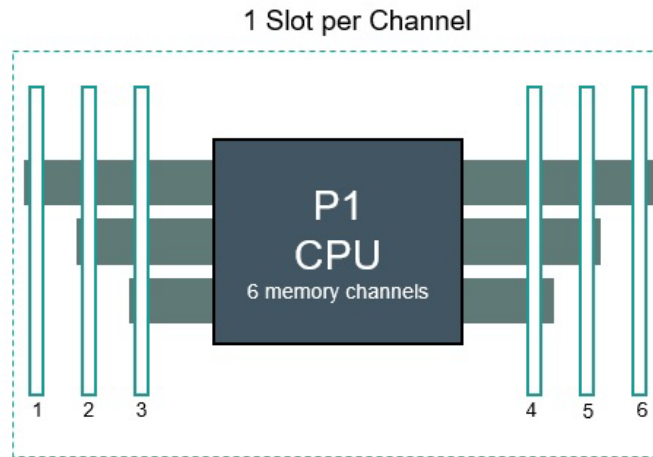

HPE ML110 Gen10 Server (Front of Server)

1 DIMM				4		
2 DIMMs				4	5	
3 DIMMs				4	5	6
4 DIMMs		2	3	4	5	
5 DIMMs*		2	3	4	5	6
6 DIMMs	1	2	3	4	5	6

HPE ProLiant Gen10 slot per CPU DIMM population order.

Notes: Unbalanced, not recommended

General Memory Population Rules and Guidelines:

- Install DIMMs only if the corresponding processor is installed.
- White DIMM slots denote the first slot to be populated in a channel.
- Mixing of DIMM types (UDIMM, RDIMM, and LRDIMM) is not supported.
- The maximum memory speed is a function of the memory type, memory configuration, and processor model.
- The maximum memory capacity is a function of the number of DIMM slots on the platform, the largest DIMM capacity qualified on the platform, the number and model of installed processors qualified on the platform.
- For details on the HPE Server Memory Options Population Rules, visit: <http://www.hpe.com/docs/memory-population-rules>.
- To realize the performance memory capabilities listed in this document, HPE DDR4 SmartMemory is required. For additional information, please see the [HPE DDR4 SmartMemory QuickSpecs](#).



Memory

DIMM Type	Register DIMM (RDIMM)			
HPE SKU P/N	P00918-B21	815098-B21	815098-B21	815100-B21
SKU Description	HPE 8GB (1x8GB) Single Rank x8 DDR4-2933 CAS-21-21-21 Registered Smart Memory Kit	HPE 16GB (1x16GB) Single Rank x4 DDR4-2666 CAS-19-19-19 Registered Smart Memory Kit	HPE 16GB (1x16GB) Single Rank x4 DDR4-2666 CAS-19-19-19 Registered Smart Memory Kit	HPE 32GB (1x32GB) Dual Rank x4 DDR4-2666 CAS-19-19-19 Registered Smart Memory Kit
DIMM Rank ->	Single Rank (1R)	Single Rank (1R)	Dual Rank (2R)	Dual Rank (2R)
DIMM Capacity ->	8GB	16GB	16GB	32GB
Voltage	1.2V	1.2V	1.2V	1.2V
DRAM depth [bit]	1Gb	2Gb	2Gb	2Gb
DRAM Width [bit]	x8	x4	x4	x4
DRAM Density	8Gb	8Gb	8Gb	8Gb
CAS Latency	19-19-19	19-19-19	19-19-19	19-19-19
DIMM Native Speed (MT/s)	2933 MT/s	2933 MT/s	2933 MT/s	2933 MT/s
HPE Server Memory Speed (MT/s): Intel Xeon® Gold 52xx Processors *				
1 DIMM Per Channel	2666 MT/s		2666MT/s	2666MT/s
HPE Server Memory Speed (MT/s): Intel Xeon® Silver 42xx Processors *				
1 DIMM Per Channel	2400 MT/s		2400 MT/s	2400 MT/s
HPE Server Memory Speed (MT/s): Intel Xeon® Bronze 32xx Processors *				
1 DIMM Per Channel	2133 MT/s		2133 MT/s	2133 MT/s

Notes:

- *Intel Xeon® Gold Processor #5222 supports 2933MT/s.
- * Intel Xeon® Gold Processor #5215 & 5218N supports 2666MT/s.

DIMM Type	Register DIMM (RDIMM)		
HPE SKU P/N	815097-B21	815098-B21	815100-B21
SKU Description	HPE 8GB (1x8GB) Single Rank x8 DDR4-2666 CAS-19-19-19 Registered Smart Memory Kit	HPE 16GB (1x16GB) Single Rank x4 DDR4-2666 CAS-19-19-19 Registered Smart Memory Kit	HPE 32GB (1x32GB) Dual Rank x4 DDR4-2666 CAS-19-19-19 Registered Smart Memory Kit
DIMM Rank ->	Single Rank (1R)	Single Rank (1R)	Dual Rank (2R)
DIMM Capacity ->	8GB	16GB	32GB
Voltage	1.2V	1.2V	1.2V
DRAM depth [bit]	1Gb	2Gb	2Gb
DRAM Width [bit]	x8	x4	x4
DRAM Density	8Gb	8Gb	8Gb
CAS Latency	19-19-19	19-19-19	19-19-19
DIMM Native Speed (MT/s)	2666 MT/s	2666 MT/s	2666 MT/s
HPE Server Memory Speed (MT/s): Intel Xeon® Gold 51xx Processors *			
1 DIMM Per Channel	2400 MT/s	2400MT/s	2400MT/s
HPE Server Memory Speed (MT/s): Intel Xeon® Silver 41xx Processors *			
1 DIMM Per Channel	2400 MT/s	2400 MT/s	2400 MT/s
HPE Server Memory Speed (MT/s): Intel Xeon® Bronze 31xx Processors *			
1 DIMM Per Channel	2133 MT/s	2133 MT/s	2133 MT/s

Notes:

- *Intel Xeon® Gold Processor #5122 supports 2666MT/s.
- *The maximum memory speed is a function of the memory type, memory configuration, and processor model.

For details on the HPE Server Memory speed, visit: <https://www.hpe.com/docs/memory-speed-table>



Memory

Standard and Maximum Memory Capacity (Pre-configured Models)

Pre Configured Models	Standard Memory	Maximum Memory Plus Optional Memory	Standard Memory Replaced with Optional Memory
3204	8 GB (1x8 GB RDIMM)	168 GB (8 GB + 5x32GB)	192 GB (6x32 GB)
4208	16 GB (1x16 GB RDIMM)	176 GB (16 GB + 5x32 GB)	192 GB (6x32 GB)
4210	16 GB (1x16 GB RDIMM)	176 GB (16 GB + 5x32 GB)	192 GB (6x32 GB)
Pre Configured Models	Standard Memory	Maximum Memory Plus Optional Memory	Standard Memory Replaced with Optional Memory
3104	8 GB (1x8 GB RDIMM)	168 GB (8 GB + 5x32GB)	192 GB (6x32 GB)
4110	16 GB (1x16 GB RDIMM)	176 GB (16 GB + 5x32 GB)	192 GB (6x32 GB)

DDR4 memory options part number decoder

Notes: Capacity references are rounded to the common gigabyte (GB) values.

- 8GB = 8,192 MB
- 16GB = 16,384 MB
- 32GB = 32,768 MB

For more information on memory, please see the Memory Quickspecs: [HPE DDR4 SmartMemory](#)

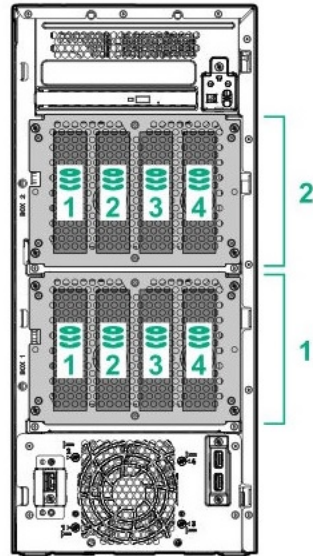

Storage

**4-bay LFF non-hot-plug model**

- 1) x 1-4 4 x LFF SATA Non-hot-plug Hard Drive Bays
- 2) x 1-4 4 x LFF SATA Non-hot-plug Hard Drive Bays (optional)

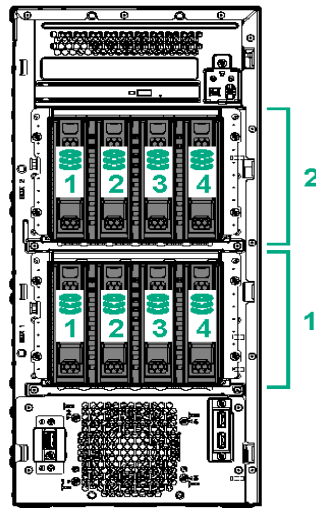
**4-bay LFF hot-plug drive model**

- 1) x 1-4 4 x LFF SAS/SATA Hot Pluggable Hard Drive Bays
- 2) x 1-4 4 x LFF SAS/SATA Hot Pluggable Hard Drive Bays (optional)



Storage

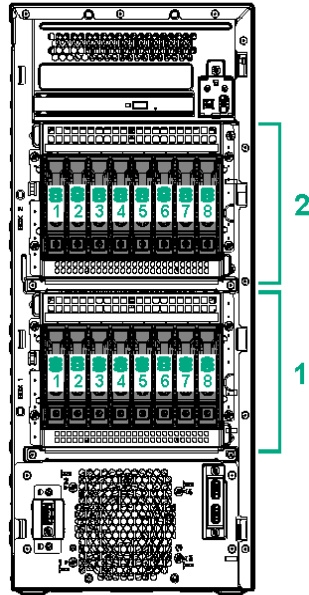

8-bay SFF hot-plug drive model

- 1) x 1-8 8 x SFF SATA/SSD Hot Pluggable Hard Drive Bays
 - 2) x 1-8 8 x SFF SATA/SSD Hot Pluggable Hard Drive Bays (optional)
-



Technical Specifications

System Unit

Tower Dimensions

- 17.32 (H)x 7.68(W) x 18.92. (D) in (44 x 19.5 x 48.05 cm)

Tower Weight (approximate)

- **Minimum:**
29.82 lbs (13.5 kg)
- **Maximum:**
55.0 lbs (25.0 kg)

Input Requirements (per power supply)

- **Rated Line Voltage**
100 to 120 VAC
- **Rated Input Frequency**
For 350W & 550W Power Supply:8A (at 100~240 VAC)
50 to 60 Hz
- **Rated Input Power**
For 550 W Power Supply:< 639 W (at 100 VAC),< 605 W (at 200 VAC)
For 350 W Power Supply:< 427 W (at 100 VAC),< 427 W (at 200 VAC)

BTU Rating

- **Maximum**
For 550 W Power Supply:2204 BTU/hr (at 100 VAC),2113 BTU/hr (at 200 VAC)
For 350 W Power Supply:1452 BTU/hr (at 100 VAC),1544 BTU/hr (at 200 VAC)

Power Supply Output (per power supply)

- **Rated Steady-State Power**
For 550 W Power Supply:550 W (at 100 VAC),550 W (at 200 VAC),
- **Maximum Peak Power**
For 350 W Power Supply:350 W (at 100 VAC),350 W (at 200VAC),

System Inlet Temperature

- **Standard Operating Temperature**
10° to 35°C (50° to 95°F) at sea level with an altitude derating of 1.0°C per every 305 m (1.8°F per every 1000 ft) above sea level to a maximum of 3050 m (10,000 ft), no direct sustained sunlight. Maximum rate of change is 20°C/hr (36°F/hr). The upper limit and rate of change may be limited by the type and number of options installed. System performance during standard operating support may be reduced if operating with a fan fault or above 30°C (86°F).
- **Extended Ambient Operating Support**
For approved hardware configurations, the supported system inlet range is extended to be: 5° to 10°C (41° to 50°F) and 35° to 40°C (95° to 104°F) at sea level with an altitude derating of 1.0°C per every 175 m (1.8°F per every 574 ft) above 900 m (2953 ft) to a maximum of 3048m (10,000 ft). The approved hardware configurations for this system are listed at the URL: <http://www.hpe.com/servers/ashrae>
System performance may be reduced if operating in the extended ambient operating range or with a fan fault.
- **Non-operating**
-30° to 60°C (-22° to 140°F). Maximum rate of change is 20°C/hr (36°F/hr).



Technical Specifications

Relative Humidity (non-condensing)

- **Operating**
8% to 90% - Relative humidity (Rh), 28°C maximum wet bulb temperature, non-condensing.
- **Non-operating**
5 to 95% relative humidity (Rh), 38.7°C (101.7°F) maximum wet bulb temperature, non-condensing.

Altitude

- **Operating**
3050 m (10,000 ft). This value may be limited by the type and number of options installed. Maximum allowable altitude change rate is 457 m/min (1500 ft/min).
- **Non-operating**
9144 m (30,000 ft). Maximum allowable altitude change rate is 457 m/min (1500 ft/min).

Acoustic Noise

Listed are the declared A-Weighted sound power levels (L_{WAd}) and declared average bystander position A-Weighted sound pressure levels (L_{pAm}) when the product is operating in a 23°C ambient environment. Noise emissions were measured in accordance with ISO 7779 (ECMA 74) and declared in accordance with ISO 9296 (ECMA 109). The listed sound levels apply to standard shipping configurations. Additional options may result in increased sound levels. Please have your HPE representative provide information from the HPE EMESC website for further technical details regarding the configurations listed below.

Idle	
LWAd	4.0 Bels Entry 4.0 Bels Perf
LpAm	24.8 dBA Entry 24.1 dBA Perf
Operating	
LWAd	4.0 Bels Entry 4.0 Bels Perf
LpAm	25.1 dBA Entry 24.1 dBA Perf

Notes: Acoustics levels presented here are generated by the test configuration only. Acoustics levels will vary depending on system configuration. Values are subject to change without notification and are for reference only.

Emissions Classification (EMC) – Regulatory Information

To view the regulatory information for your product, view the Safety and Compliance Information for Server, Storage, Power, Networking, and Rack Products, available at the Hewlett Packard Enterprise Support Center:

<http://www.hpe.com/support/Safety-Compliance-EnterpriseProducts>

HPE Smart Array

For latest information on **HPE Smart Array Gen10 Controllers for HPE ProLiant DL, ML and Apollo Servers** please refer to their QuickSpecs. (E208i-a,E208i-p,E208e-p,P408i-a,P408i-p,P408e-p,P816i-a)



Technical Specifications

Environment-friendly Products and Approach - End-of-life Management and Recycling

Hewlett Packard Enterprise offers **end-of-life product return, trade-in, and recycling programs** in many geographic areas, for our products. Products returned to Hewlett Packard Enterprise will be recycled, recovered or disposed of in a responsible manner.

The EU WEEE directive (2002/95/EC) requires manufacturers to provide treatment information for each product type for use by treatment facilities. This information (product disassembly instructions) is posted on the Hewlett Packard Enterprise web site. These instructions may be used by recyclers and other WEEE treatment facilities as well as Hewlett Packard Enterprise OEM customers who integrate and re-sell Hewlett Packard Enterprise equipment.



Summary of Changes

Date	Version History	Action	Description of Change
01-Feb-2021	Version 24	Changed	Core Options section was updated. Obsolete SKUs were removed.
28-Sep-2020	Version 23	Changed	Additional Options section was updated. Obsolete SKUs were removed.
03-Aug-2020	Version 22	Changed	Configuration Information section was updated.
01-Jun-2020	Version 21	Changed	Core Options section was updated.
06-Apr-2020	Version 20	Changed	Overview, Standard Features, Service and Support, Pre Configured Models and Configuration Information sections were updated.
03-Feb-2020	Version 19	Changed	Overview, Pre Configured Models, Standard Features and Configuration Information sections were updated. Obsolete SKUs were removed.
02-Dec-2019	Version 18	Changed	Overview, Standard Features and Core Options sections were updated. Obsolete SKUs were removed. SKUs under Core Options section were updated.
07-Oct-2019	Version 17	Changed	Core Options, SMB Models and Additional Options sections were updated. Obsolete SKU was removed.
05-Aug-2019	Version 16	Changed	Configuration Information, Core Options and Additional Options. sections were updated. Obsolete SKUs were removed.
03-Jun-2019	Version 15	Changed	Overview, Standard Features, Service and Support, SMB Models, Configuration Information, Core Options, Additional Options, Memory and Storage sections were updated. The U.S. version of QuickSpecs is no longer being updated, please reference the Worldwide QuickSpecs for latest information
02-Apr-2019	Version 14	Changed	Core Options and Additional Options sections were updated.
04-Feb-2019	Version 13	Changed	SKUs descriptions were updated. Optional Features section was updated.
03-Dec-2018	Version 12	Changed	SKUs were added and deleted in Core Options Section
15-Oct-2018	Version 11	Changed	Core Options and Additional Options sections were updated SKUs descriptions were updated. Obsolete SKUs were removed from the QuickSpecs.
01-Oct-2018	Version 10	Changed	Standard Features, Configuration Information, Core Options and Additional Options sections were updated SKUs descriptions were updated.
06-Aug-2018	Version 9	Changed	Added new GPU option. Core Options and Additional Options were revised. Obsolete SKUs were removed from the QuickSpecs.
11-Jun-2018	Version 8	Changed	Smart Buy Models section for the NA version was revised.
04-Jun-2018	Version 7	Changed	Added Support up to 8 LFF NHP SATA HDDs. Added HPE DDR4 SmartMemory up to 2666 MT/s. Added Security features: iLO 5 (Security Root of Trust). Service and Support, Configuration Information – Factory Integrated Models, Core Options, Additional Options, and Memory section were revised. Obsolete SKUs were removed from the QuickSpecs.
02-Apr-2018	Version 6	Changed	SKU descriptions were updated.
05-Mar-2018	Version 5	Changed	Added new Solution Model. SMB Models section was revised. Obsolete SKUs were removed from the QuickSpecs.
05-Feb-2018	Version 4	Changed	Added new SMB offerings. Added GPGPU information.

Summary of Changes

Date	Version History	Action	Description of Change
04-Dec-2017	Version 3	Changed	Added new HPE 12TB SATA 6G LFF Hard Disk Drive. Standard Features, Pre-Configured Models, Additional Options, and Memory were revised.
16-Oct-2017	Version 2	Changed	Added HPE Support Services. Standard Features, Configuration Information – Factory Integrated Models, Core Options, Additional Options, and Memory section were revised.
25-Sep-2017	Version 1	New	New QuickSpecs.



Copyright

Make the right purchase decision.
Contact our presales specialists.



Chat



Email



Call



Get updates



© Copyright 2021 Hewlett Packard Enterprise Development LP. The information contained herein is subject to change without notice. The only warranties for Hewlett Packard Enterprise products and services are set forth in the express warranty statements accompanying such products and services. Nothing herein should be construed as constituting an additional warranty. Hewlett Packard Enterprise shall not be liable for technical or editorial errors or omissions contained herein.

Intel® and Xeon® are registered trademarks of Intel Corporation in the U.S. and other countries. Microsoft®, Windows®, and Windows Server® are U.S. registered trademarks of the Microsoft group of companies.

For hard drives, 1GB = 1 billion bytes. Actual formatted capacity is less

a00021851enw - 16054 - Worldwide - V24 - 01-February-2021